

2150

McIntosh
MC 2150

OWNER'S MANUAL

THE McINTOSH MC 2150 STEREO POWER AMPLIFIER



VARIOUS REGULATORY AGENCIES REQUIRE THAT WE BRING THE FOLLOWING INFORMATION TO YOUR ATTENTION. PLEASE READ IT CAREFULLY.

WARNING: TO PREVENT FIRE OR SHOCK HAZARD, DO NOT EXPOSE THIS UNIT TO RAIN OR MOISTURE.

The McIntosh you have purchased is a Model MC 2150. It has a serial number located on the rear panel of the chassis. Record that serial number here:

Serial Number

The model, serial number and purchase date are important to you for any future service. Record the purchase date here:

Purchase date

Upon application, McIntosh Laboratory provides a Three-Year Service Contract. Your McIntosh Authorized Service Agency can expedite repairs when you provide the Service Contract with the instrument for repair. To assist, record your Service Contract number here:

Service Contract Number

Your MC 2150 Stereo Power Amplifier is designed to perform to its specifications for many years. If you have any questions, please contact:

CUSTOMER SERVICE

McIntosh Laboratory Inc.
2 Chambers Street
Binghamton, New York 13903-9990
Phone: 607-723-3512

**Take Advantage of 3 years
of Contract Service...
Fill in the Application NOW.**

Contents

- SERVICE 1
- INSTALLATION 2
- HOW TO CONNECT 4
- THE FRONT PANEL CONTROLS
AND HOW TO USE THEM 9
- REAR PANEL INFORMATION 11
- PERFORMANCE LIMITS 12
- PERFORMANCE CHARTS 13
- TECHNICAL DESCRIPTION 15
- BLOCK DIAGRAM 17

McINTOSH THREE YEAR SERVICE CONTRACT

An application for A THREE YEAR SERVICE CONTRACT is included with this manual.

The terms of the contract are:

1. McIntosh will provide all parts, materials and labor needed to return the measured performance of the instrument to the original performance limits. The SERVICE CONTRACT does not cover any shipping costs to and from the authorized service agency or the factory.
2. Any McIntosh authorized service agency will repair McIntosh instruments at normal service rates. To receive service under the terms of the SERVICE CONTRACT, the SERVICE CONTRACT CERTIFICATE must be presented when the instrument is taken to the service agency.
3. Always have service done by a McIntosh authorized service agency. If the instrument is modified or damaged as a result of unauthorized repair, the SERVICE CONTRACT will be cancelled. Damage by improper use or mishandling is not covered by the SERVICE CONTRACT.
4. The SERVICE CONTRACT is issued to you as the original purchaser. To protect you from misrepresentation, this contract cannot be transferred to a second owner.
5. To receive the SERVICE CONTRACT, your purchase must be made from a McIntosh franchised dealer.
6. Your completely filled in application for the SERVICE CONTRACT must be post-marked within 30 days of the date of purchase of the instrument.
7. To receive the SERVICE CONTRACT, all information on the application must be filled in. The SERVICE CONTRACT will be issued when the completely filled in application is received by McIntosh Laboratory Incorporated in Binghamton, New York.
8. Units in operation outside the United States and Canada are not covered by the McIntosh SERVICE CONTRACT, irrespective of the place of purchase. Nor are units acquired outside the U.S.A. and Canada, the purchasers of which should consult with their dealer to ascertain what, if any, service contract or warranty may be available locally.

Installation

Remove the three screws securing the shipping pallet and remove the pallet and bottom shipping pad. Remove the plastic shipping bag. If the amplifier is to be mounted in a cabinet or rack mount, remove the four plastic feet from the bottom of the amplifier. If the amplifier is used alone, leave the feet screwed to the amplifier. They are necessary to hold the amplifier above the supporting surface to allow adequate ventilation. **The amplifier can not be used without ventilation through the chassis and heatsinks.**

INSTALLATION IN A McINTOSH CABINET

Install the amplifier by following the instructions enclosed with the cabinet.

INSTALLATION IN A CUSTOM CABINET

The trouble-free life of an electronic instrument is greatly extended by providing sufficient ventilation around it. This prevents the buildup of high internal temperatures that cause deterioration. Allow enough clearance so that cool air can enter at the bottom of the cabinet and be vented from the top. With adequate ventilation the instrument can be mounted in any position. The recommended minimum space for installation is 15 inches (38.1 cm) deep, 17 inches (43.2 cm) wide, and 6 inches (15.2 cm) high.

The MC 2150 can be housed in a McIntosh L52 cabinet, installed in a custom cabinet or mounted in a standard 19 inch rack by using the addition of RACK MOUNTING ADAPTERS (RMA 5). The MC 2150 weights 58 pounds (26.3 kg). In any installation it is necessary to provide proper support for the weight. The mounting methods described and the amplifier have been designed to accomodate the weight. Be sure that the panel in which the amplifier is mounted can also handle the weight.

UNPACKING THE AMPLIFIER

Remove the amplifier and hardware package from the outer and inner shipping cartons. Be careful to avoid maring or placing a strain on the edges of the front panel. Place the amplifier upside down on a surface that will support the transformer and heat-sinks but will not touch the edge of the front panel. A pad from the shipping carton can be used for this purpose.

Vertical mounting of the amplifier requires careful consideration. The total weight is supported by the panel and shelf on which the amplifier is to be mounted. Thought should be given to providing a means for raising the amplifier out of the panel. More consideration should be given to providing adequate ventilation at the panel in vertical mounting. The heat sinks are at the rear of the chassis permitting the heat to pass over the entire chassis. It is then trapped behind the panel causing the overall temperature to rise. In any case, air flow for cooling can be improved by the use of a properly installed low noise fan. Adequate cooling will extend the life of the amplifier.

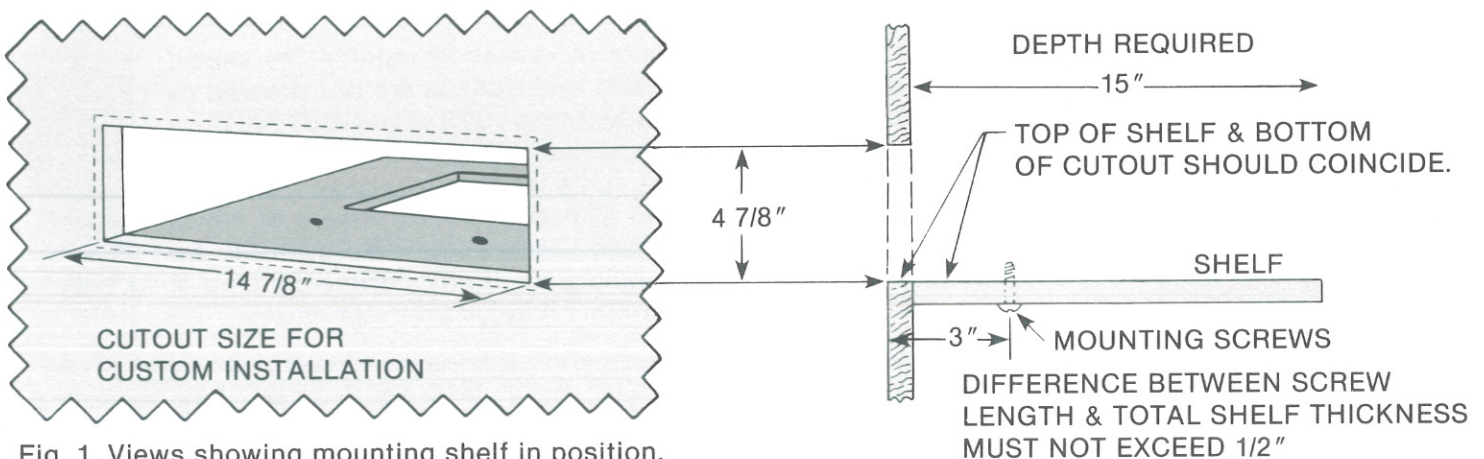

Fig. 1. Views showing mounting shelf in position.

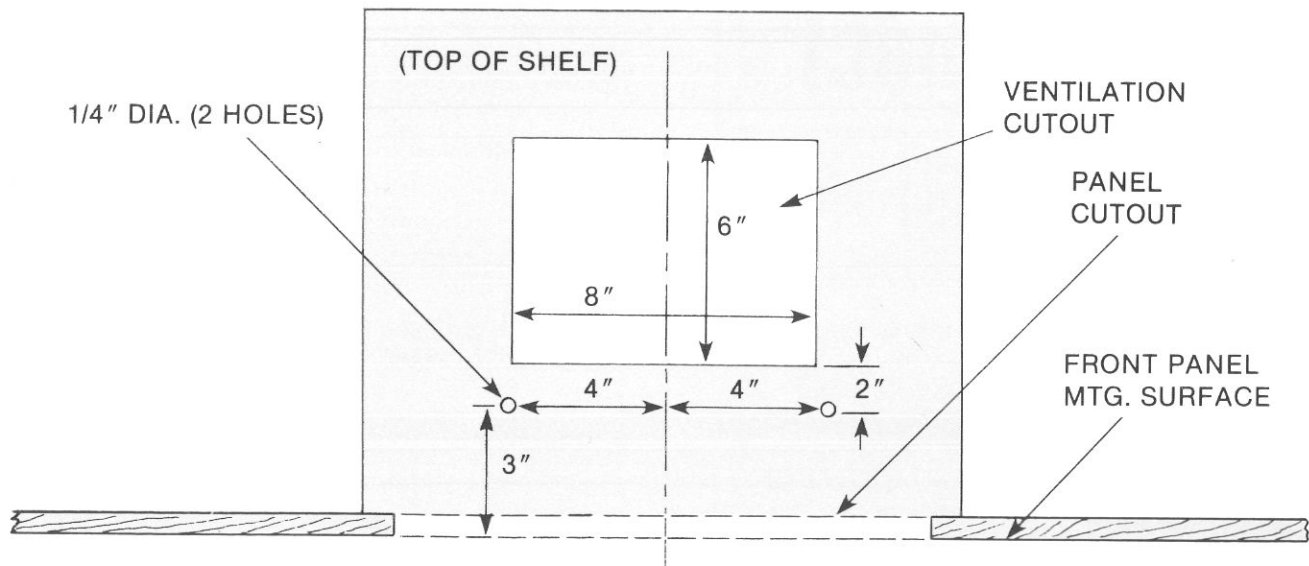

Fig. 2. Top view of the panel cutout and mounting shelf.

INSTALLATION PROCEDURE

1. Mark for Position

Mark the cabinet panel where the instrument is to be installed. The solid lines in Fig. 1 represent the outline of the rectangular cutout to be made and also represent the outside dimensions of the chassis. Make sure to clear internal shelves, partitions, or any equipment. The broken line represents the outside dimension of the panel.

2. Drill Holes

Using a drill bit slightly larger than the tip of your saw blade, drill one hole at each of two diagonally opposite corners. The holes should barely touch the inside edge of the outline.

3. Saw Panel Cutout

Place the blade of the saw in one of the holes. Sawing carefully on the inside of the lines, first make the two long cuts and then the two short cuts. After the rectangular opening has been cut out, use a file to square the corners and smooth any irregularities in the cut edges.

4. Shelf Installation

In the same way mark and saw the ventilation cutout shown in Fig. 2. Also drill two 1/4 inch holes for the mounting screws. Install the shelf to the cabinet panel. It must be able to support the total weight of the instrument.

5. Install Instrument

Guide the AC power cord through the panel opening to the back of the cabinet; then, slide the instrument into the opening until its front panel is flush with the cabinet panel. Secure the amplifier to the shelf with #10 wood screws of the proper length.

1/2 inch thick shelf—use 1 inch screws

3/4 inch thick shelf—use 1 1/4 inch screws

Do not use longer screws. They may penetrate electronic components inside the chassis and

cause severe damage. The screw length must not exceed the shelf thickness by more than 1/2 inch.

INSTALLATION IN A 19 INCH RACK

The optional RMA5 RACK MOUNTING ADAPTERS install on each end of the amplifier front panel. On each side of the amplifier, three screws secure the front panel bracket to the chassis. See Fig. 3. Remove these three screws, place the RACK MOUNTING ADAPTER over the screw holes, and replace the screws. The entire amplifier weight is transmitted through the RACK MOUNTING ADAPTERS to the rack. Additional support for the amplifier can be provided at the rear of the chassis as desired.

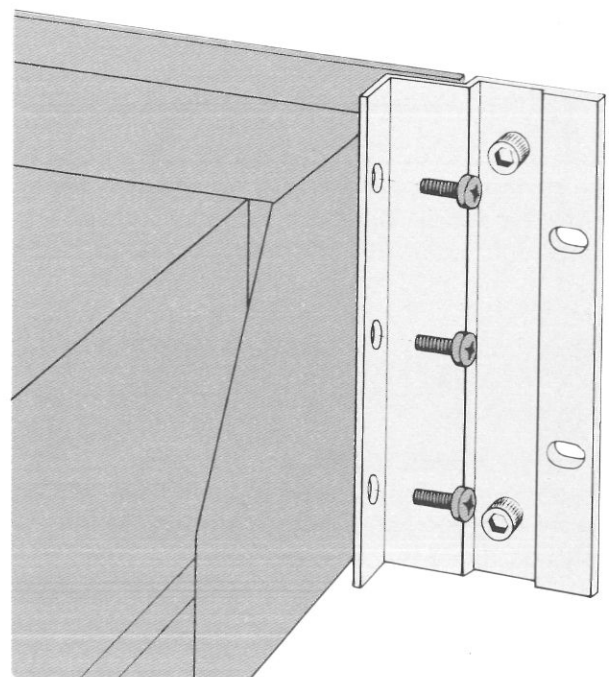
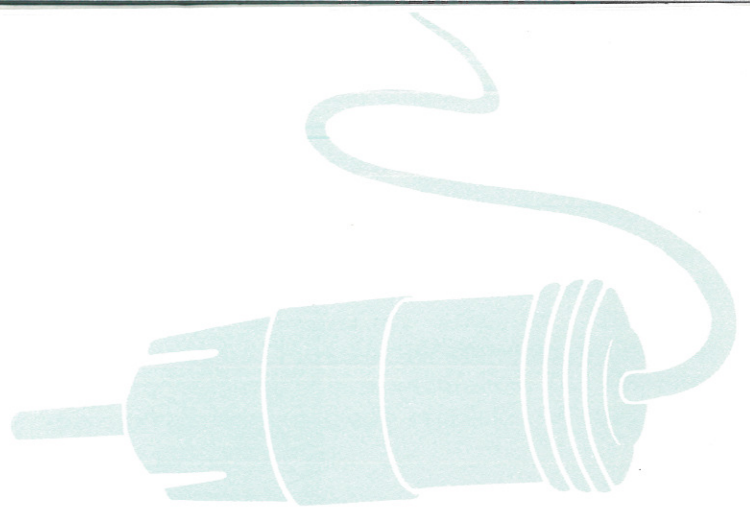

Fig. 3. Rack Mounting Adapters installed.

How to Connect



INPUT CONNECTIONS STEREO OPERATION

Use shielded cables to connect the signal from the preamplifier or signal source to the power amplifier. To minimize the possibility of hum the shielded cables should be run parallel to each other or loosely twisted together. Locate the cables away from speaker leads and AC power cords. All connections are made on the back panel of the MC 2150.

For stereo operation, the left output of the preamplifier should be plugged into the Left INPUT jack of the power amplifier. The right output of the preamplifier should be plugged into the Right/MONO INPUT jack of the power amplifier.

In stereo operation the MODE SWITCH must be in the STEREO position.

MONOPHONIC OPERATION

For monophonic operation the MODE switch on the back panel of the MC 2150 must be placed in one of the MONO positions. For the proper choice, see the section on monophonic output connections. Connect a shielded cable from the signal source to the Right/MONO INPUT jack of the MC 2150. The Left INPUT is not used.

Be certain that the MC 2150 is never operated in the stereo mode with the outputs connected for monophonic operation. Should the MODE SWITCH be left in the STEREO position and the outputs remain strapped for a mono parallel load, one amplifier channel will attempt to drive the other which causes high circulating currents and overheating.

OUTPUT CONNECTIONS

Be certain the loudspeakers connected to the MC 2150 are capable of handling the power output of the amplifier.

Selection of the proper gauge wire to connect the loudspeakers to the amplifier preserves the quality of sound reproduction for which the loudspeakers have been designed. If undersize wire is used, resistance is added to the amplifier/loudspeaker

combination which adversely affects the performance. Added resistance causes depreciation of damping characteristics, modification of frequency response and reduction in power to the loudspeaker.

Use lamp cord or wire with similar insulation to connect the speakers to the amplifier. In all cases, the leads to and from the speaker should be twin parallel conductor or twisted pair. When using 8 ohm speakers and for the normally short distances of under 30 feet between the amplifier and speaker, #18 wire or larger can be used. For distances over 30 feet a larger diameter wire is required. Select the correct size from the chart below. The DC resistance of the speaker leads should be less than 5% of the speaker impedance. Resistance of the leads must be computed for the length of wire both to and from the speaker or speakers.

Wire Gauge	MAXIMUM WIRE LENGTHS			
	For 4 Ohm Load		For 8 Ohm Load	
	Feet	Meters	Feet	Meters
18	15	4.57	30	9.14
16	25	7.62	50	15.24
14	40	12.19	80	24.38
12	60	18.29	120	36.58
10	100	30.48	200	60.96

Wire lengths above represent the wire resistance equal to 5% of the speaker impedance.

For multiple speaker operation, run separate leads from the amplifier to the speakers.

STEREO OPERATION

First check the impedance of the speaker to be connected. This is usually found on the speaker system near the terminals or in the speaker literature. The proper terminals on the MC 2150 can then be used. Connect the + or rated impedance terminal of the left speaker to the corresponding LEFT OUTPUT terminal on the amplifier. Connect the - or the common terminal of the left speaker to the left COMMON output terminal of the amplifier. In the same way connect the right speaker to the amplifier RIGHT OUTPUT terminals.

When multiple speakers are to be connected to the amplifier, the combined load impedance for the speakers must be calculated. The load must then be connected to the appropriate amplifier impedance tap. Use this table to aid in selecting the correct impedance match:

STEREO NORMAL CONNECTIONS	
Load impedance in ohms	Connect for:
0.8 to 1.6	1 ohm output
1.6 to 3.2	2 ohm output
3.2 to 6.4	4 ohm output
6.4 and up	8 ohm output

If a load impedance is used that is lower than the output impedance tap, then reduced power and possible distortion will result. If a load impedance is used that is higher than the output impedance tap, then neither the signal nor the amplifier will be harmed but the power available is reduced.

STEREO CONSTANT VOLTAGE LINE OPERATION:

When speakers are to be used in many different rooms, or many speakers are needed to cover a large area with sound, constant voltage line operation can be used. This is convenient for larger home background music systems or for industrial installations. Appropriate line matching transformers must be used at each speaker location. The 4 ohm output provides the standard 25 volt constant voltage line output. In the stereo mode 150 watts is available for each channel.

STEREO CONSTANT VOLTAGE LINE CONNECTIONS	
For output voltage of	Connect for:
25 volts	4 ohms

MONOPHONIC OR SINGLE CHANNEL OPERATION

When the MC 2150 is used as a monophonic or single channel power amplifier the two channels can be combined in two different ways. Both will combine to produce up to 300 watts but the available impedances are different. MONO BRIDGE offers a few higher impedance connections than MONO PARALLEL. Either mode can be used for 2 or 4 ohm operation. Performance is identical. Monophonic constant voltage line operation can also be used. The outputs are connected as described below.

When using the MONO BRIDGE mode, output impedances of 2, 4, 8, and 16 ohms are accommodated. Output connections are made by connecting to the output terminals as listed below. Note that neither output terminal is at ground potential.

MONO BRIDGE CONNECTIONS		
Load Impedance In Ohms	Connect - Speaker Lead To:	Connect + Speaker Lead To:
2	Left 1 Ohm Terminal	Right 1 Ohm Terminal
4	Left 2 Ohm Terminal	Right 2 Ohm Terminal
8	Left 4 Ohm Terminal	Right 4 Ohm Terminal
16	Left 8 Ohm Terminal	Right 8 Ohm Terminal

When using the MONO PARALLEL mode, output impedances of 1/2, 1, 2, and 4 ohms are accommodated. Connect as listed below. The common output terminals are at ground potential.

MONO PARALLEL CONNECTIONS		
Load Impedance In Ohms	Connect - Speaker Lead To:	Connect + Speaker Lead To:
1/2	Either Left or Right Common Terminal	Both Left and Right 1 Ohm Terminals
1	Either Left or Right Common Terminal	Both Left and Right 2 Ohm Terminals
2	Either Left or Right Common Terminal	Both Left and Right 4 Ohm Terminals
4	Either Left or Right Common Terminal	Both Left and Right 8 Ohm Terminals

MONOPHONIC CONSTANT VOLTAGE LINE OPERATION

When the MC 2150 is used in MONO for constant voltage line operation, the 2 ohm output provides the standard 25 volt constant voltage line output. Appropriate line matching transformers must be used at each speaker location. In this mode a total of 300 watts of monophonic power is available.

MONO CONSTANT VOLTAGE LINE CONNECTIONS	
For output voltage of	Connected for:
25 volts	2 ohms

Be certain that the MC 2150 is never operated in the stereo mode with the outputs connected for monophonic operation. Should the MODE SWITCH be left in the STEREO position and the outputs remain strapped for a mono parallel load, one channel will attempt to drive the other which causes high circulating currents and overheating.

AC POWER

The MC 2150 operates on 120 volts 50/60 Hz and requires 6 amps at full rated output. Plug the power cord into a suitable source. The auxiliary AC OUTLET on the MC 2150 is not fused or switched.

Stereophonic Connections

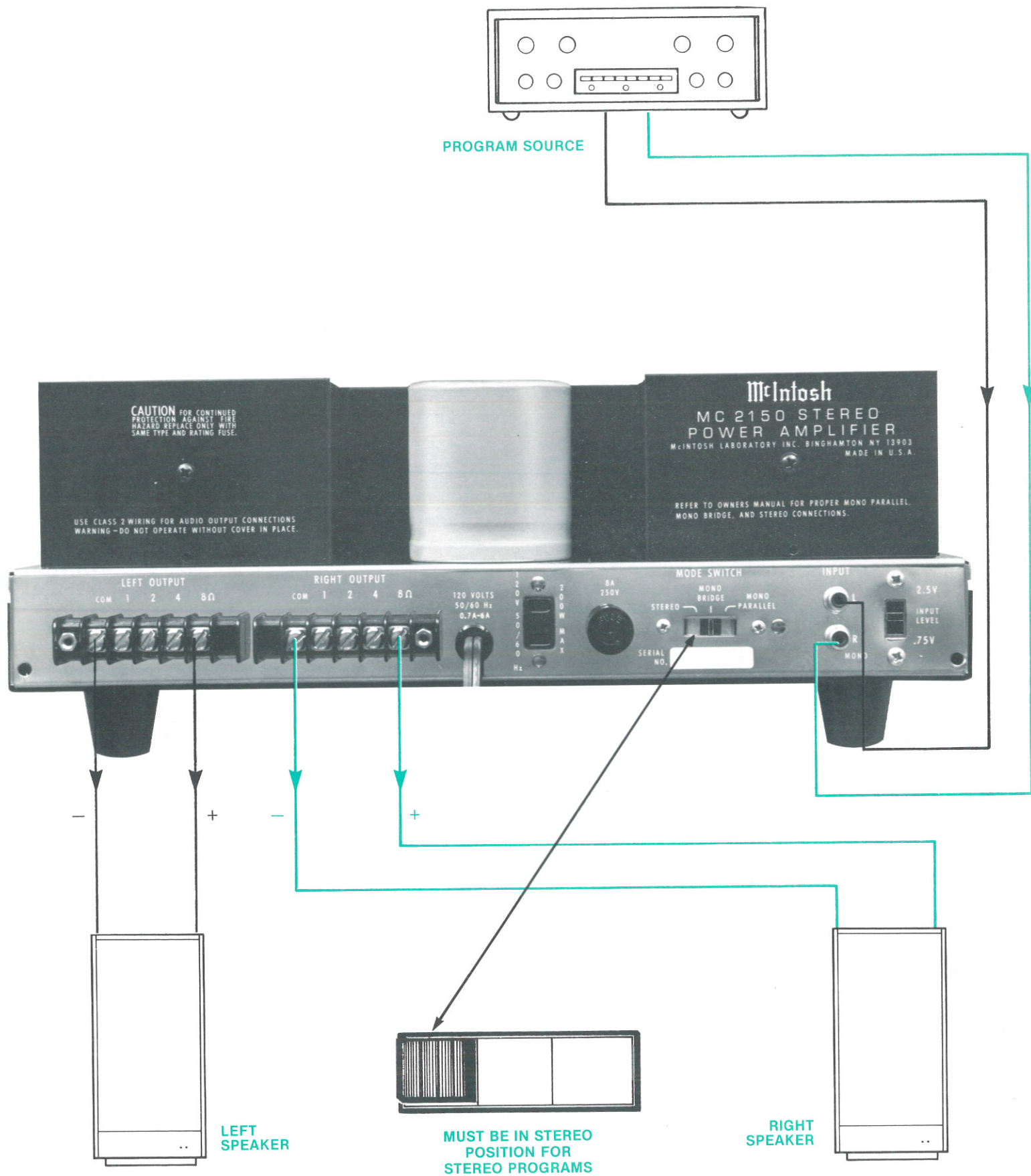

Mono-Bridge Connections

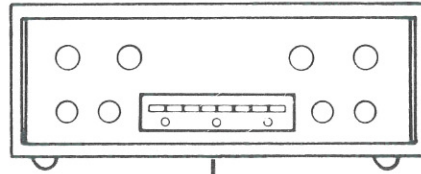

PROGRAM SOURCE

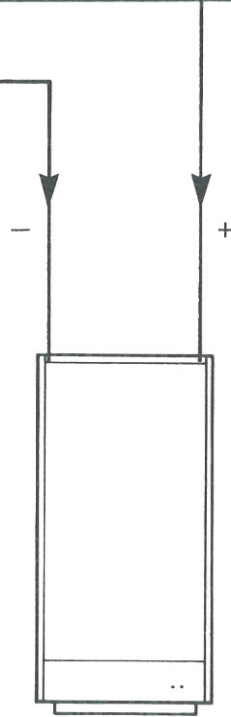
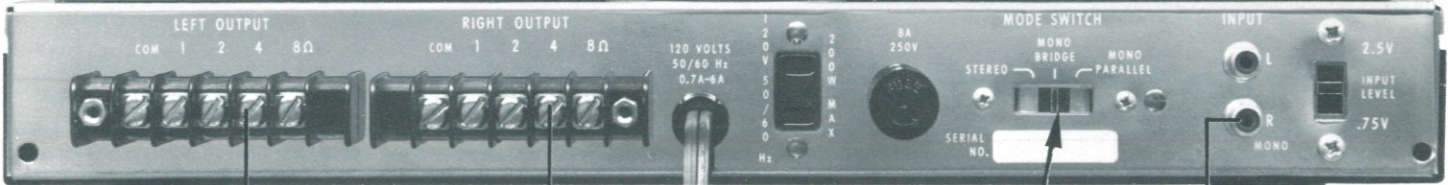
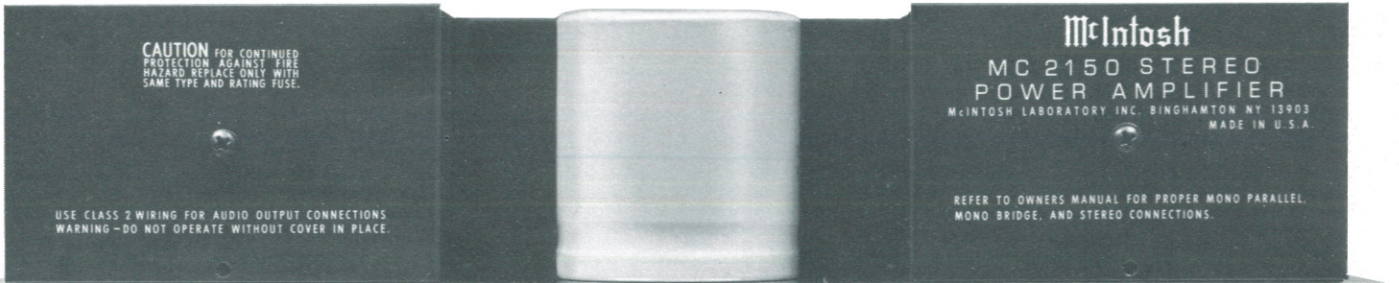

(CONNECTIONS FOR 8 OHM SPEAKER ILLUSTRATED)

SPEAKER

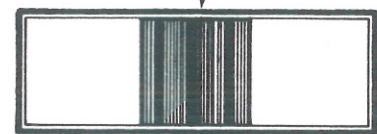

CONNECTIONS SHOWN FOR MONO WHEN MODE SWITCH IS IN THE MONO-BRIDGE POSITION

Mono-Parallel Connections

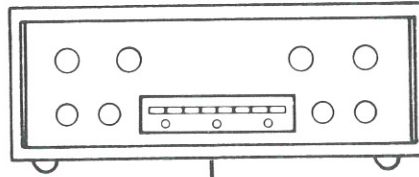

PROGRAM SOURCE

CAUTION FOR CONTINUED PROTECTION AGAINST FIRE HAZARD REPLACE ONLY WITH SAME TYPE AND RATING FUSE.

USE CLASS 2 WIRING FOR AUDIO OUTPUT CONNECTIONS WARNING - DO NOT OPERATE WITHOUT COVER IN PLACE.

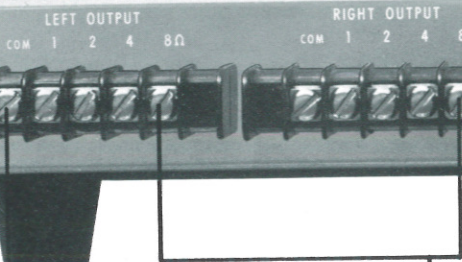
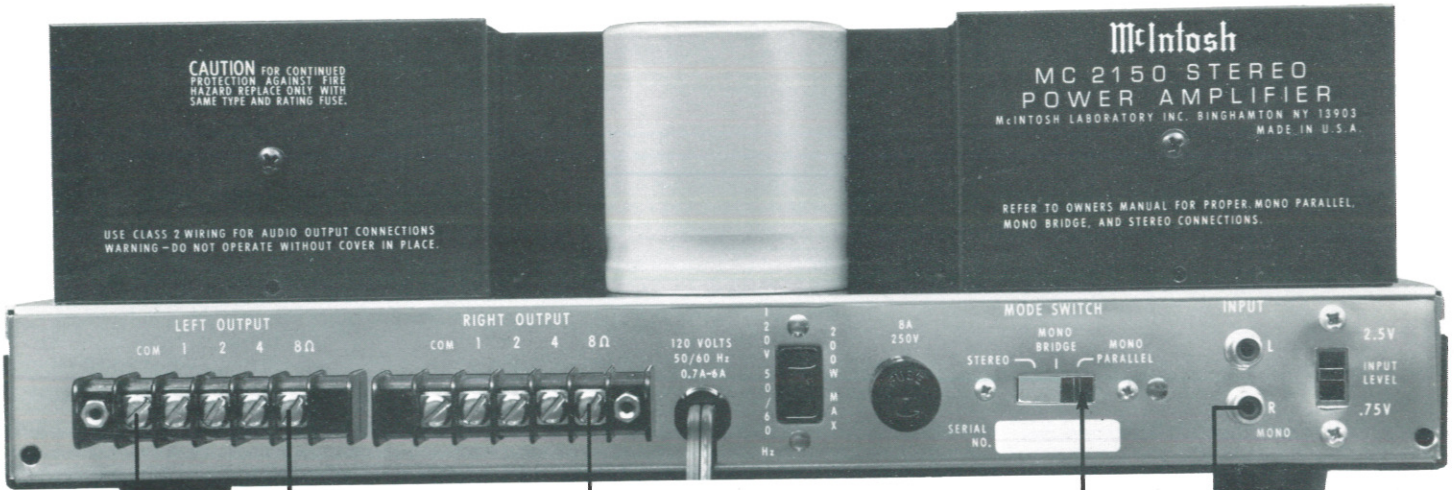

(CONNECTIONS FOR 4 OHM SPEAKER ILLUSTRATED)

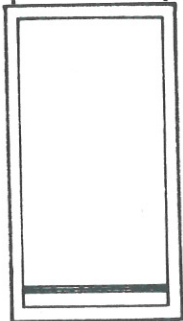

SPEAKER

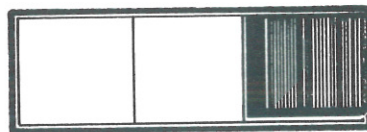

CONNECTIONS SHOWN FOR MONO WHEN MODE SWITCH IS IN THE MONO-PARALLEL POSITION

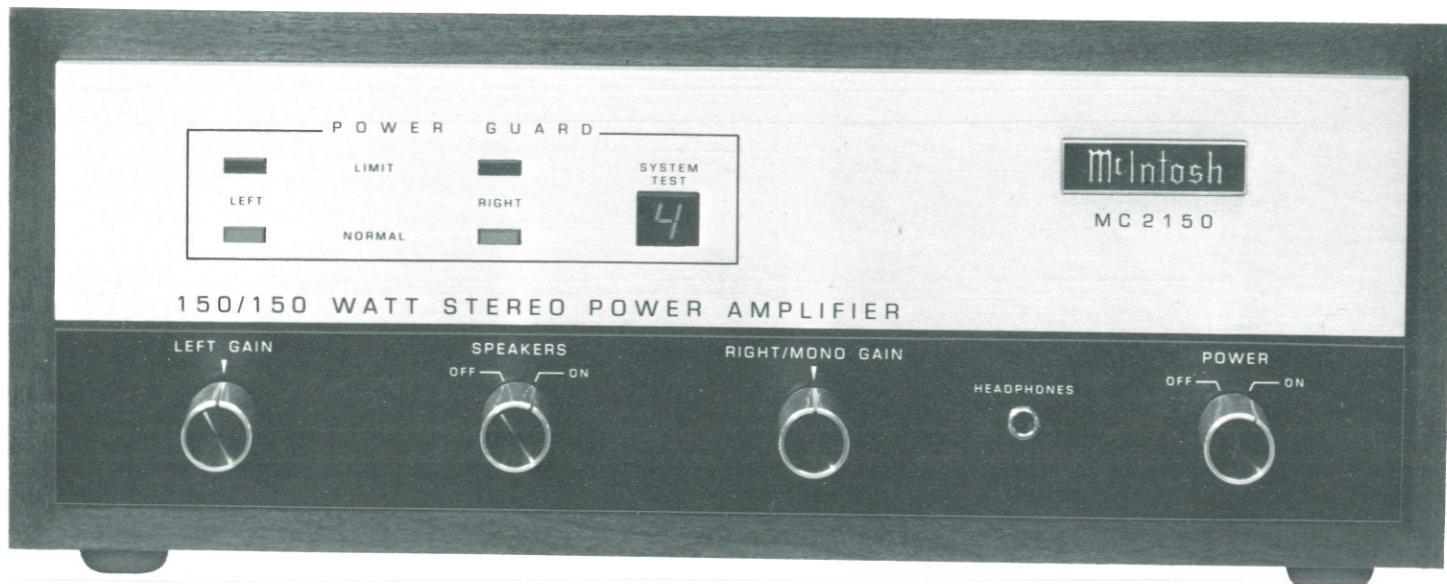

The Front Panel Controls and How to Use Them

GAIN CONTROLS

When your system is first connected, turn the LEFT and RIGHT/Mono GAIN controls to minimum (fully counterclockwise) before turning the power on. The controls can then be advanced to the desired settings; normally maximum (fully clockwise). When using the MC 2150 for MONO-BRIDGE or MONO-PARALLEL operation, use the RIGHT/Mono GAIN control. The LEFT channel control is not used in the MONO mode of operation.

HEADPHONES

The stereo HEADPHONE jack is located next to the power switch. The headphones are driven by left and right preamp sections in the MC 2150. The preamp circuits have been designed to power low impedance dynamic headphones. High impedance headphones will work but at a reduced listening level. The HEADPHONE output is not affected by the SPEAKER switch.

SPEAKERS

The SPEAKER switch turns the loudspeakers on or off. The switch must be in the ON position to hear sound from the loudspeakers. When the switch is OFF, you can listen to headphones in private.

POWER

The POWER switch turns the MC 2150 ON or OFF. Each time the power is turned on, the red SYSTEM TEST readout and green POWER GUARD lights will be alternately visible as the self test sequence automatically proceeds. The switch does not control the power outlet on the back panel. If you wish to control the AC power from a preamplifier control center, plug the AC cord of the MC 2150 into a controlled outlet on the rear of the preamplifier control center and leave the POWER switch in the ON position.

POWER GUARD

Each channel of the MC 2150 is equipped with a POWER GUARD circuit. POWER GUARD prevents the MC 2150 from causing high distortion when the input is overdriven. It acts automatically when distortion exceeds 0.5%. As long as the amplifier is not overdriven, the NORMAL green POWER GUARD lights will stay on. If the input signal is excessive for either or both channels, the corresponding red LIMIT light will go on instead. The sound will remain clear and undistorted. When the excessive driving signal is removed, the NORMAL green lights will return.

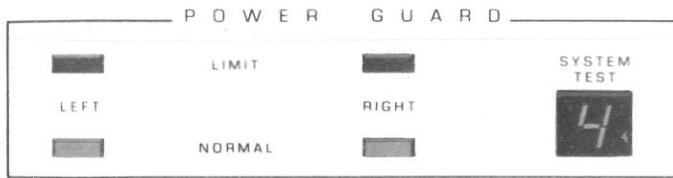

SYSTEM TEST

The MC 2150 contains a new automatic test circuit. Each time the amplifier is turned on, an LED digit illuminates to indicate which test is being performed. Starting with the numeral 7, it makes the required measurement and verifies if it is within tolerance by flashing the green Power Guard lights. It then counts down to six, performs and verifies the next test, then five, four, three, etc. until it reaches "1" and then the speakers turn on. A "beep" tone is heard each time a test is performed. If a circuit should fail, both red "limit" lights will come on and the sequence will stop at that point. Speaker turn on will not occur until the fault has been corrected; thereby protecting your system from further damage.

There are two user switches associated with the auto test circuit. They are located on the amplifier top panel. One switch controls the speed of the countdown (SLOW or FAST). The other controls the presence of the beep tone (ON or OFF).

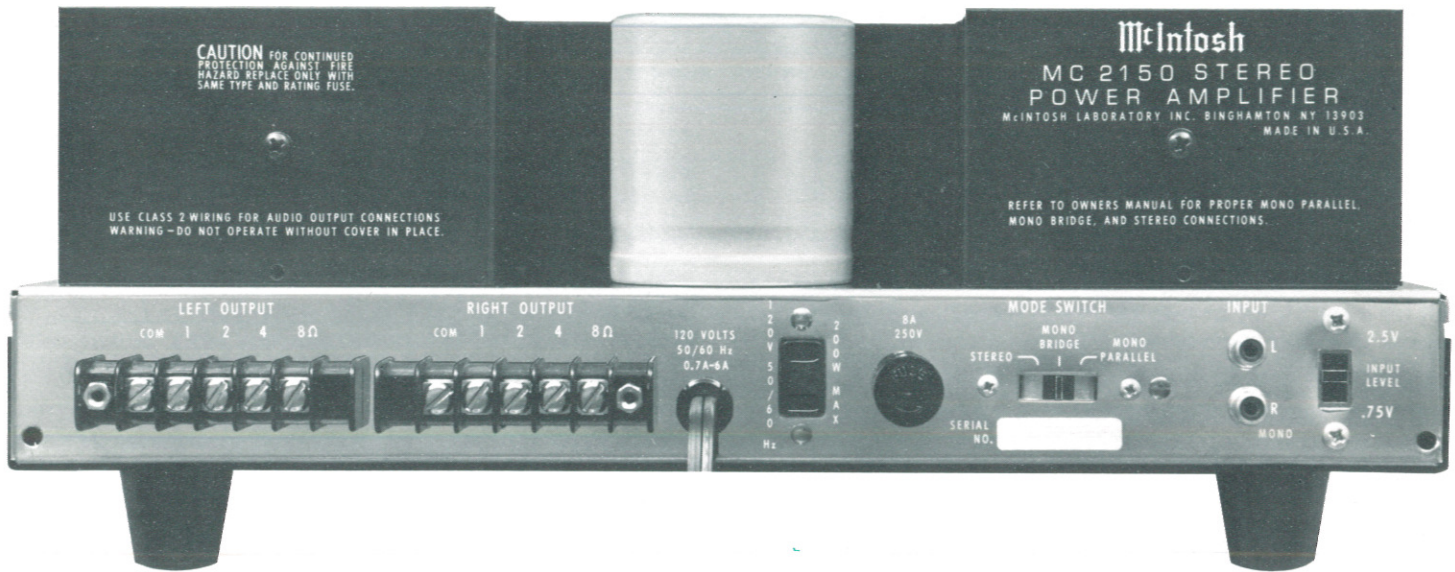

Rear Panel Information

MODE SWITCH

The MC 2150 will operate in three modes, Stereo, Mono Bridge, and Mono Parallel. The Mono modes differ in the loads they will drive and the connection sequence to the speaker terminals.

LEFT and RIGHT OUTPUT TERMINALS

For stereo operation, output impedances of 1, 2, 4 and 8 ohms have been provided on secure, screw type barrier strips for each channel. For monophonic operation proper interconnection provides 0.5, 1, 2, 4, 8, and 16 ohms from the same barrier strips. See page 4 for connecting instructions.

INPUT JACKS

In the stereo mode of operation, both input jacks accept signal. In the mono mode of operation only the Right (MONO) channel input jack accepts signal and the Left channel input jack is disconnected.

INPUT LEVEL

The Input sensitivity of the MC 2150 is 0.75 volts or 2.5 V depending on the position of the INPUT LEVEL switch. All McIntosh preamplifiers have been designed to deliver 2.5 volts output with rated input. For the best signal to noise ratio when using McIntosh source equipment, place the INPUT LEVEL switch in the 2.5 V position and the front panel LEFT and RIGHT/MONO GAIN controls in the fully clockwise position. If more gain is desired the 0.75 V position may be used. For source equipment other than McIntosh, set the switch in the position nearest to the stated output rating of the source equipment.

AC POWER

The input to the MC 2150 is 120 volts 50/60 Hz at up to 6 amps. The primary circuit is protected by an 8 Amp Fuse.

Performance Limits

PERFORMANCE GUARANTEE

Performance Limits are the maximum deviation from perfection permitted for a McIntosh instrument. We promise you that when you purchase a new MC 2150 from a McIntosh franchised dealer, it will be capable of or can be made capable of performance at or exceeding these limits or you can return the unit and get your money back. McIntosh is the only manufacturer that makes this statement.

PERFORMANCE

McIntosh audio power ratings are in accordance with the Federal Trade Commission Regulation of November 4, 1974 concerning power output claims for amplifiers used in home entertainment products.

POWER OUTPUT

STEREO

150 watts minimum sine wave continuous average power output, per channel, both channels operating into 1 ohm, 2 ohms, 4 ohms, or 8 ohms load impedance, which is:

- 12.2 volts RMS across 1 ohm
- 17.3 volts RMS across 2 ohms
- 24.5 volts RMS across 4 ohms
- 34.6 volts RMS across 8 ohms

MONO

300 watts minimum sine wave continuous average power output into 0.5 ohm, 1 ohm, 2 ohms, 4 ohms, 8 ohms, or 16 ohms load impedance, which is:

- 12.2 volts RMS across 0.5 ohm
- 17.3 volts RMS across 1 ohm
- 24.5 volts RMS across 2 ohms
- 34.6 volts RMS across 4 ohms
- 49.0 volts RMS across 8 ohms
- 69.3 volts RMS across 16 ohms

OUTPUT LOAD IMPEDANCE

STEREO

1 ohm, 2 ohms, 4 ohms, and 8 ohms; separate terminals are provided for each output.

MONO-PARALLEL

0.5 ohm, 1 ohm, 2 ohms, and 4 ohms; obtained by connecting together the appropriate terminals of both channels.

MONO-BRIDGED

2 ohms, 4 ohms, 8 ohms, or 16 ohms, balanced to common connections.

RATED POWER BAND

20 Hz to 20,000 Hz

TOTAL HARMONIC DISTORTION

STEREO

0.02% maximum harmonic distortion at any power level from 250 milliwatts to 150 watts per channel from 20 Hz to 20,000 Hz, both channels operating.

MONO

0.02% maximum harmonic distortion at any power level from 250 milliwatts to 300 watts from 20 Hz to 20,000 Hz.

INTERMODULATION DISTORTION

STEREO

0.02% maximum if instantaneous peak power output is 300 watts or less per channel with both channels operating for any combination of frequencies, 20 Hz to 20,000 Hz.

MONO

0.02% maximum if instantaneous peak power output is 600 watts or less for any combination of frequencies, 20 Hz to 20,000 Hz.

FREQUENCY RESPONSE (at one watt output)

- 20 Hz to 20,000 Hz +0 -0.25 dB.
- 10 Hz to 100,000 Hz +0.25 -1 dB.

NOISE AND HUM

95 dB below rated output.

RATINGS

DAMPING FACTOR

Greater than 30

INPUT IMPEDANCE

50,000 ohms.

INPUT SENSITIVITY

Switchable: 0.75 volt or 2.5 volts—level control provided for higher input voltages.

POWER GUARD

Clipping is prevented and THD does not exceed 2% with up to 20 dB overdrive at 1 KHz.

GENERAL INFORMATION

POWER REQUIREMENTS

120 volts 50/60 Hz 0.7 to 6 amps.

SEMICONDUCTOR COMPLEMENT

- 72 silicon transistors
- 37 silicon rectifiers and diodes
- 9 integrated circuits

MECHANICAL INFORMATION

SIZE

Front panel measures 16 inches wide (40.7 cm) by 5-7/32 inches high (13.2 cm). Chassis measures 14-9/16 inches wide (37 cm) by 5 inches high (12.7 cm) by 14-1/2 inches deep (36.8 cm), including connectors. Knob clearance required is 1 1/2 inch (3.8 cm) in front of mounting panel

FINISH

Front panel is anodized gold. Chassis is chrome and black

WEIGHT

58 pounds (26.3 kg) net, 71 pounds (32.2 kg) in shipping carton

Performance Charts

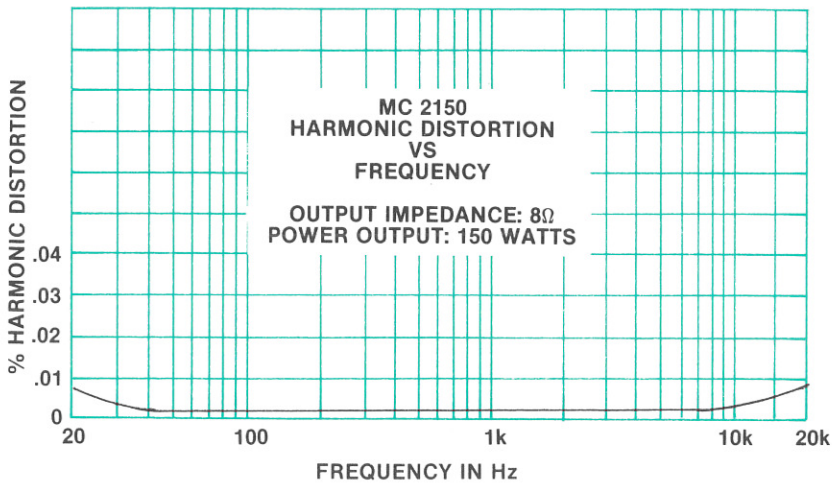
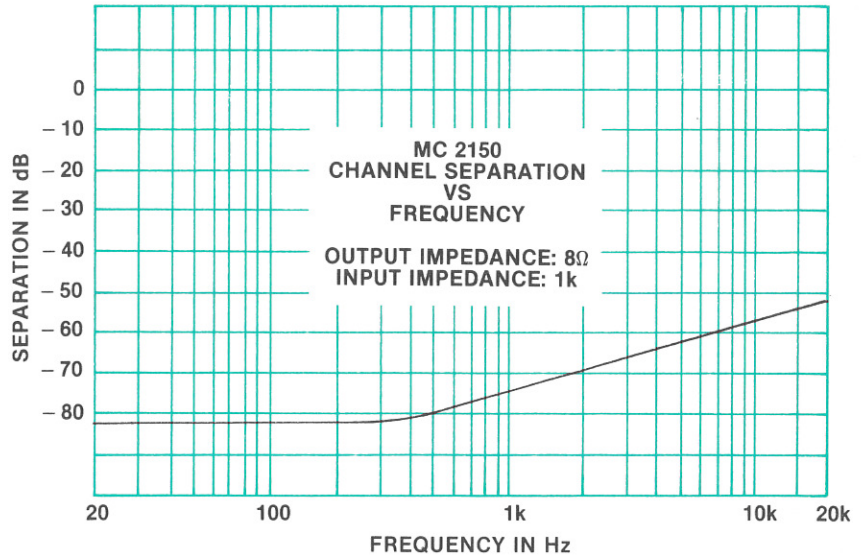
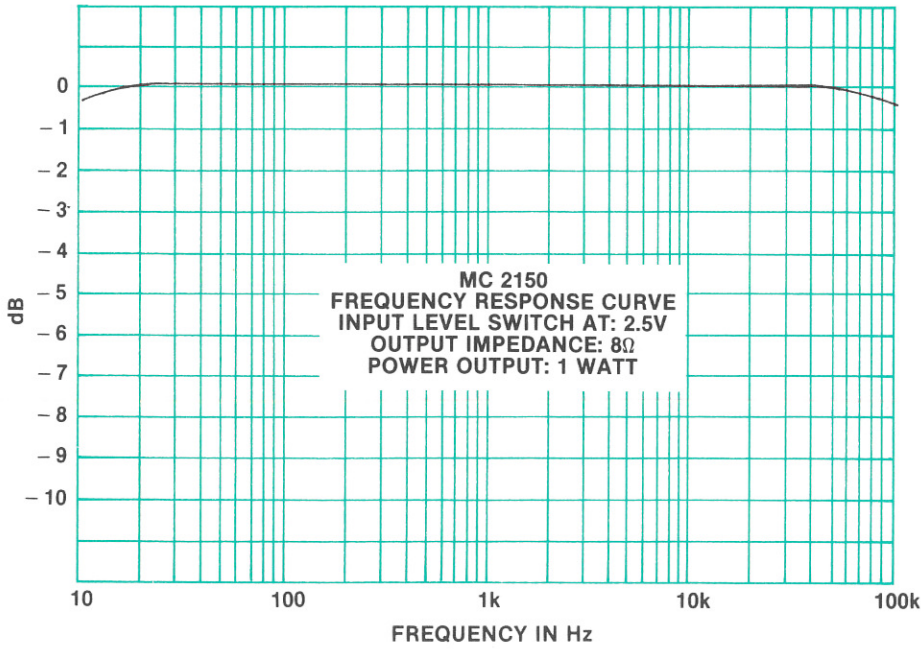

PERFORMANCE CHARTS ARE FOR ONE STEREO CHANNEL WITH BOTH CHANNELS OPERATING. MONO OPERATION IS IDENTICAL EXCEPT POWER IS DOUBLED FOR THE SINGLE MONO OUTPUT.

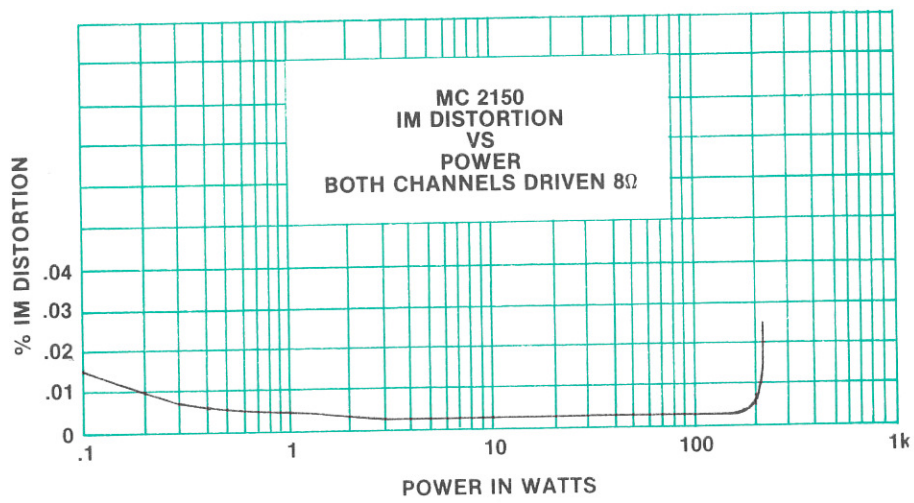
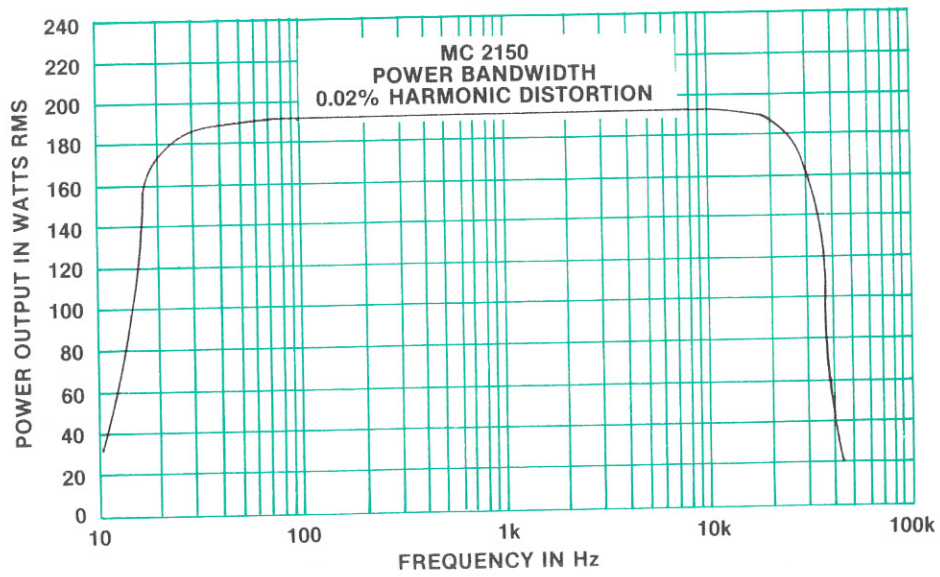

Technical Description

INPUT AMPLIFIER

Each channel contains a complete seven transistor low power input amplifier. An input differential transistor pair provides high input impedance and low noise. The outputs of this pair are combined in a current mirror circuit which drives a class A amplifier stage. The output stage follows this amplifier and is a complementary pair of transistors biased class AB. The output signal drives the metering circuit, headphone jack, and the high power output amplifier. This discrete transistor amplifier design was selected for low noise, low distortion, adequate power output capability to drive headphones, and freedom from turn on and turn off transients.

In the MONO mode of operation the input signal feeds only the right input amplifier via the RIGHT/MONO GAIN control. The right input amplifier feeds both output power amplifier sections. When MONO BRIDGE MODE is selected the left channel input amplifier is used as a phase inverter. The output channels then operate 180° out of phase with respect to each other which is the correct arrangement for bridge output connections. When the MONO PARALLEL MODE is selected the channels operate in phase. The channels, of course, also operate in phase for the STEREO MODE.

OUTPUT POWER AMPLIFIER

The input amplifiers feed the output amplifiers through an electronic switch. The switch eliminates turn-on and turn-off transients and is used for speaker switching. A junction FET and LED/light dependent resistor network make up the switch. This combination allows the lowest possible distortion when the amplifier is on and the highest isolation when the amplifier is off. The control signal to the switch is off during the auto test countdown. Therefore, transients that may come into the amplifier from source equipment will not be amplified or reach the loudspeaker. Since the HEADPHONE output and meters are powered by the input amplifier, their operation is not affected by the SPEAKER switch or the turn on delay system.

The first stage of the output power amplifier is a differential transistor pair biased for best linearity. The offset to the differential pair is adjustable. Correct adjustment allows the lowest possible distortion at low frequencies. A current mirror circuit combines the differential outputs into one signal which is then amplified by a following class A voltage amplifier. Both the differential transistors and the voltage amplifier are supplied by active current

sources. The results are lower distortion and cleaner turn-on characteristics.

The driver stage follows the voltage amplifier. The driver consists of a complementary pair of power transistors biased class AB. Next, two complementary pairs of rugged power transistors make up the power output stage. All power transistors are mounted on conservatively sized anodized aluminum heat sinks. Because of a unique connection of the bias network, the output transistors operate class B and exhibit no crossover distortion often associated with class B operation. The heat sinks, therefore, remain cool when there is no output.

The amplifier output signal is fed to the output terminals through the output autotransformer. The McIntosh designed interleaved multifilar wound autotransformer is used to properly match the amplifier to stereo output load taps for 1, 2, 4 and 8 ohms. The MC 2150 will deliver full power over the entire audio frequency range at any of these impedances. The autotransformer also protects speakers from damage in the event of amplifier failure. Should a direct current component appear in the output, it is shunted through the low DC resistance of the autotransformer. DC cannot damage the speaker.

A McIntosh patented Sentry Monitoring circuit constantly monitors the output signal and instantly reacts to prevent overload of the output transistors. At signal levels up to rated output this circuit has high impedance and has no effect upon the output. If the power output exceeds design maximum, the Sentry Monitoring circuit operates to limit the signal to the output transistors. In the event of a short circuit across the amplifier output or severe impedance mismatch the Sentry Monitoring circuit will protect the output transistors from failure. Both positive and negative halves of the output signal are monitored and protected independently.

POWER GUARD PROTECTION CIRCUIT

The McIntosh patented Power Guard circuit eliminates amplifier clipping due to overdrive. The circuit also illuminates red LIMIT indicator lamps when the amplifier is driven beyond its maximum output capacity. Power Guard prevents loudspeaker damage and eliminates harsh output distortion caused by amplifier clipping.

The Power Guard circuit consists of a waveform comparator which monitors the wave shape of the amplifier input and output signals. Normally there is

no difference in wave shape between these signals and the comparator produces no output. When the amplifier is driven beyond its maximum power capacity a difference will develop. If this exceeds 0.5% (equivalent to 0.5% total harmonic distortion) the comparator output causes the red LIMIT indicators to light. If there is a further increase the comparator output activates an electronic attenuator at the amplifier input to reduce the amplifier gain, this automatic attenuator will hold the amplifier output to its maximum undistorted value regardless of the degree of overdrive to the amplifier. The amplifier may be overdriven by 20 dB before the output distortion exceeds 2%.

The comparator is an especially compensated operational amplifier integrated circuit. Its output is detected by a full wave bridge that feeds signals to the control circuitry for the LIMIT and NORMAL indicators and to the electronic attenuator at the amplifier input. The attenuator is a light emitting diode/light dependent resistor network selected especially for its low distortion and proper time constant characteristics.

SYSTEM TEST CIRCUIT

When AC line power is applied to the MC 2150 the System Test circuit functions to verify operating

potentials at 7 test locations within the amplifier. Upon applying power a digital display lights with the number 7. The digit is driven by a counter that steps down at a 1 second or .4 second rate. Each time the digit changes, electronic switches select the outputs of various voltage comparators connected to test points in the amplifier. If voltages are normal the green Power Guard lights flash, there is an audible beep produced by an internal sounder, and the display decreases to the next test number. When the count passes number 1 the loudspeakers connect and the display blanks off. If a fault condition exists the counter stops and both red Power Guard limit lights go on. The digit displayed indicates the circuit at fault. Servicing the amplifier is thereby simplified.

The test circuit uses logic counter, BCD decoder, lamp driver, and voltage comparator integrated circuits.

POWER SUPPLY

The power supply is a conventional full wave bridge rectifier arrangement providing plus and minus 50 volts DC. Electronic regulators step down and regulate plus and minus 15 volt sources for low level circuits and plus 5 volts for the logic circuits. Thermistors are used in the power transformer primary circuit to limit the turn-on current.



McIntosh

**McINTOSH LABORATORY INC.
2 CHAMBERS ST., BINGHAMTON, N.Y. 13903-9990
607-723-3512**

The continuous improvement of its products is the policy of
McIntosh Laboratory Incorporated who reserve the right to
improve design without notice.

Printed in U.S.A.