

McIntosh
MC 2205

THE McINTOSH MC 2205 SOLID STATE STEREO POWER AMPLIFIER

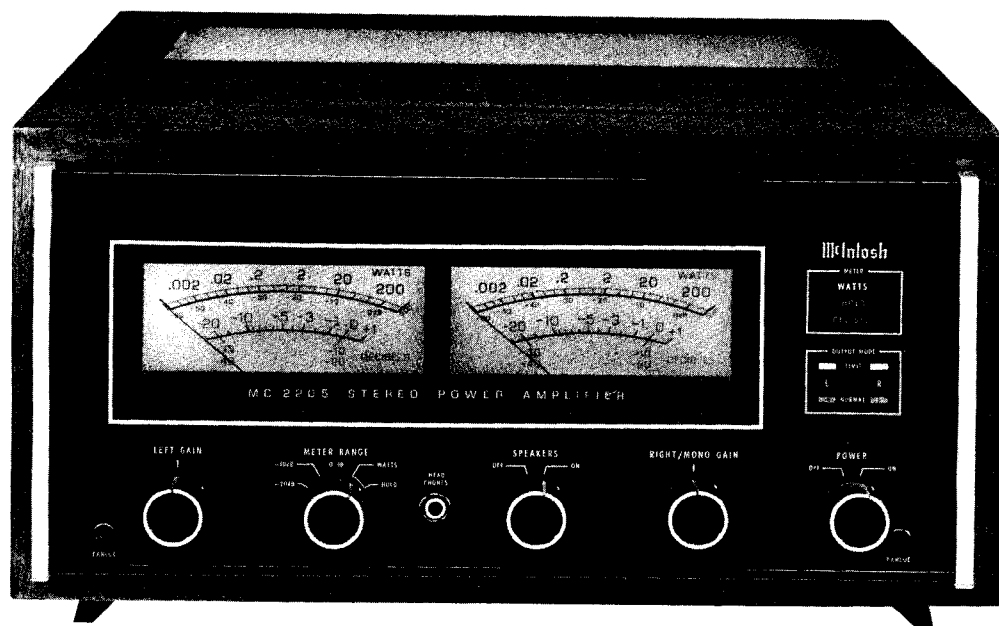

Reading Time: 31 Minutes

Price \$12.

Your MC 2205 Stereo Power Amplifier will give you many years of pleasant and satisfactory performance. If you have any questions, please contact:

CUSTOMER SERVICE

McIntosh Laboratory Inc.
2 Chambers Street
Binghamton, New York 13903
Phone: 607-723-3512

WARNING: TO PREVENT FIRE OR SHOCK HAZARD, DO NOT EXPOSE THIS UNIT TO RAIN OR MOISTURE.

Take Advantage of 3 years
of FREE Service . . .
Fill in the Application NOW.

Contents

SERVICE	1
INSTALLATION	2
HOW TO CONNECT	4
FRONT PANEL INFORMATION	8
REAR PANEL INFORMATION	10
PERFORMANCE LIMITS AND RATINGS	11
PERFORMANCE CHARTS	12
TECHNICAL DESCRIPTION	14
BLOCK DIAGRAM	16

THREE YEAR SERVICE CONTRACT

An application for a FREE THREE YEAR SERVICE CONTRACT is included with this manual.

The terms of the contract are:

1. McIntosh will provide all parts, materials and labor needed to return the measured performance of the instrument to the original performance limits free of any charge. The SERVICE CONTRACT does not cover any shipping costs to and from the authorized service agency or the factory.
2. Any McIntosh authorized service agency will repair all McIntosh instruments at normal service rates. To receive the free service under the terms of the SERVICE CONTRACT, the SERVICE CONTRACT CERTIFICATE must accompany the instrument when taken to the service agency.
3. Always have service done by a McIntosh authorized service agency. If the instrument is modified or damaged, as a result of unauthorized repair the SERVICE CONTRACT will be cancelled. Damage by improper use or mishandling is not covered by the SERVICE CONTRACT.
4. The SERVICE CONTRACT is issued to you as the original purchaser. To protect you from misrepresentation this contract cannot be transferred to a second owner.
5. For your protection McIntosh selects only dealers who have technical competence to guide purchasers fairly, and provide service when necessary. To receive the SERVICE CONTRACT your purchase must be made from a McIntosh franchised dealer.
6. Your completely filled in application for a SERVICE CONTRACT must be postmarked within 30 days of the date of purchase of the instrument.
7. To receive the SERVICE CONTRACT all information on the application must be filled in. The SERVICE CONTRACT will be issued when the completely filled in application is received at McIntosh Laboratory Incorporated in Binghamton, New York.



The PANLOC system of installing equipment conveniently and securely is a direct result of McIntosh research. By depressing the two PANLOC buttons on the front panel of the MC 2205, the instrument either can be locked firmly in place or unlocked so that the chassis can be slid forward, giving you easy access to the top and rear panels.

The trouble-free life of an electronic instrument is greatly extended by providing sufficient ventilation to prevent the buildup of high internal temperatures that cause deterioration. Allow enough clearance so that cool air can enter at the bottom of the cabinet and be vented from the top. With adequate ventilation the instrument can be mounted in any position. The recommended minimum space for in-

stallation is 15 inches (38.1 cm) deep, 17 inches (43.2 cm) wide, and 8 inches (20.3 cm) high.

The MC 2205 weighs 85 pounds (38.6 kg). A $\frac{3}{4}$ " thick mounting panel is recommended to properly support the weight in either vertical or horizontal installation. If less than $\frac{3}{4}$ " panel thickness must be used, be certain to provide additional support at the rear of the PANLOC brackets. Vertical mounting the MC 2205 requires careful consideration. The total weight is transmitted to the panel on which the amplifier is to be mounted. The PANLOC system and amplifier are designed for the weight so be sure that the cabinet panel and its mounting can also handle the weight. Thought should be given to providing a means for raising the MC 2205 out of the cabinet panel on its PANLOC slides. Providing an access for lifting from the back of the instrument would help to prevent the necessity of lifting the entire weight with the fingers. More consideration should be given to providing adequate ventilation at the cabinet panel in vertical mounting. When the heat sinks are at the rear of the chassis, heat can pass over the entire chassis and be trapped behind the cabinet panel causing the overall temperature to rise. Air flow for cooling can be improved by the use of a properly installed low noise fan. Adequate cooling will extend the life of the components.

To install the instrument in a McIntosh cabinet, follow the instructions that are enclosed with the cabinet. For any other type of installation:

1. **Unpack from Carton**
Remove the instrument PANLOC brackets, hardware package, and mounting template from the carton. Remove the MC 2205 from its plastic bag and place it upside down on the shipping pallet; unscrew the four plastic feet from the bottom of the chassis.
2. **Mark for Position**
Place the mounting template in position to cover the area of the cabinet panel where the instrument is to be installed, and tape it in place. The broken lines that represent the outline of the rectangular cutout also represent the outside dimensions of the chassis. Make

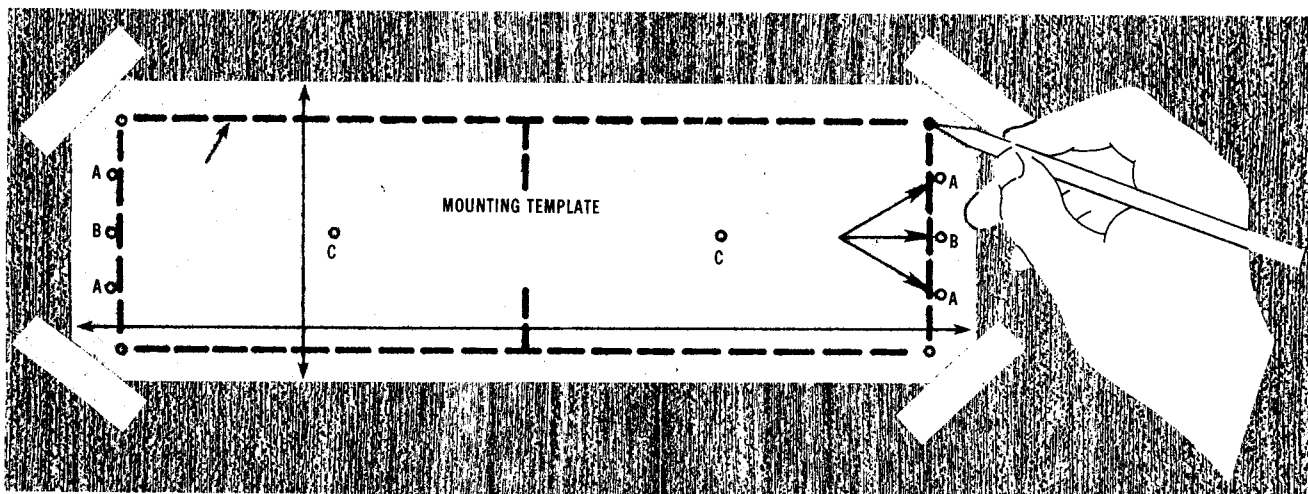

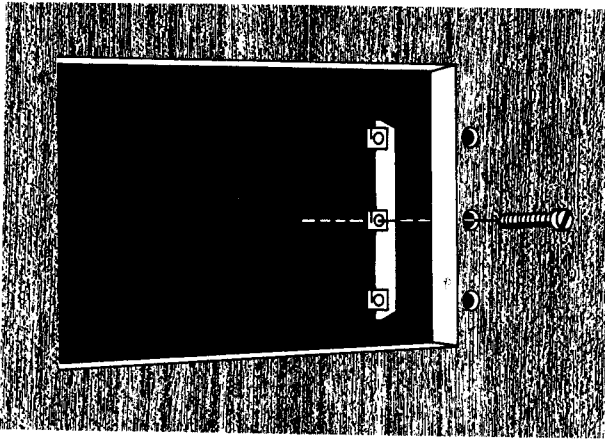

sure these lines clear shelves, partitions, or any equipment. With the template in place, first mark the six A and B holes and the four small holes that locate the corners of the cutout. Then, join the four corner markings with pencil lines, using the edge of the template as a straightedge.

3. Drill Holes

Using a drill with a 3/16 inch bit held perpendicular to the panel, drill the six A and B holes. Then, using a drill bit slightly wider than the tip of your saw blade, drill one hole at each of two diagonally opposite corners. The holes should barely touch the inside edge of the pencilled outline. **Before taking the next step, make sure that the six A and B holes have been drilled.**

4. Saw Panel Cutout

Sawing carefully on the inside of the pencilled lines, first make the two long cuts and then the two short. After the rectangular opening has been cut out, use a file to square the corners and smooth any irregularities in the cut edges.

5. Install Mounting Strips

In the hardware package you will find two mounting strips and two sets of machine screws. For panels that are less than 1/2 inch thick, use the 3/4 inch screws; for panels that are more than 1/2 inch thick, use the 1 1/4 inch screws.

Starting at the right-hand side of the panel, insert a screw of the proper length into the center hole in the panel, marked B on the template. On the back of the

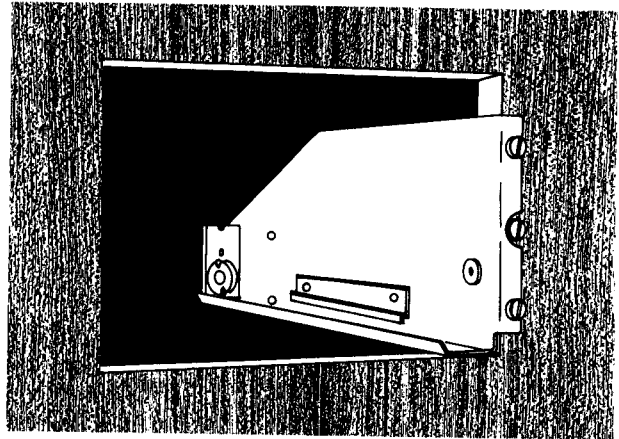

panel, align a mounting strip with the holes in the panel and tighten the screw until the screwhead is pulled slightly into the wood.

Repeat this procedure to attach the mounting strip to the left side of the panel.

6. Attach PANLOC Brackets

Using two screws of the proper length in the A holes on each side, attach the PANLOC brackets to the cabinet panel; the short flange is mounted against the front (face) of the cabinet panel. The screws pass through the PANLOC bracket flange, the cabinet panel, and then through the mounting strips previously mounted.

7. Install Instrument

Guide the AC power cord through the panel opening to the back of the cabinet; then, slide the instrument into the opening carefully so that the rails on the bottom of each side of the chassis engage the tracks on the mounting brackets. Continue to slide the instrument into the cabinet until it is stopped by the adjust position latches. Press the latches inward, this permits the instrument to slide into the cabinet until its front panel is flush with the cabinet panel. Depress the PANLOC buttons at the lower left and right corners of the instrument panel to lock the unit firmly in the cabinet. Depressing the PANLOC buttons again will unlock the instrument so that it can be slid forward to the adjust position; pressing inward on the adjust position latches permits removal from the cabinet.

How to Connect

INPUT

STEREO OR TWIN AMPLIFIER OPERATION

Use shielded cables to connect the signal from the pre-amplifier or signal source to the power amplifier. To minimize the possibility of hum the shielded cables should be run parallel to each other or loosely twisted together. Locate the cables away from speaker leads and AC power cords. All connections are made on the back panel of the MC 2205.

For stereo operation, the left output of the preamplifier should be plugged into the Left input jack of the power amplifier. The right output of the preamplifier should be plugged into the Right (MONO) input jack of the power amplifier.

In stereo or twin amplifier operation the MODE SWITCH must be in the STEREO position. For twin amplifier operation a separate signal source can be connected to each input.

MONOPHONIC OR SINGLE CHANNEL OPERATION

A shielded cable from the signal source is plugged into the Right (MONO) input jack of the MC 2205 only. The MODE SWITCH on the back panel of the amplifier must be placed in the MONO position. In the MONO position the output of the right channel input amplifier is fed to both left and right power amplifiers. The Left INPUT is disconnected. Only the signal fed into the Right (MONO) input will be amplified. Should the MODE SWITCH be left in the STEREO position and the output transformers remain strapped for a monophonic load, one channel will attempt to drive the other which causes high circulating currents and overheating.

Be certain that the MC 2205 is never operated in the stereo mode with the outputs connected for monophonic operation.

OUTPUT

For multiple speaker operation, run separate leads from the amplifier to the speakers. Because of the high power available from the MC 2205, be sure to use large diameter speaker leads. In all cases, the leads to and from the

speaker should be twin conductor or twisted together. Use lamp cord, bell wire, or wire with similar type of insulation to connect the speakers to the amplifier. For the normally short distances of under 20 feet between the amplifier and speaker, #18 wire or larger can be used. For distances over 20 feet between the amplifier and speaker use larger diameter wire. Select the correct size wire for the wire distance from the chart. It is recommended that the DC resistance of the speaker leads not be over 5% of the speaker impedance. Up to 10% can be tolerated. Resistance of the leads should be computed for the length of wire both to and from the speaker or speakers.

Be certain the loudspeakers connected to the MC 2205 are capable of handling the power output of the amplifier.

STEREO OR TWIN AMPLIFIER OPERATION

Check the impedance of the speaker which is usually identified on the speaker itself or in the speaker owner's manual. Connect a lead from the common terminal of the left speaker to the amplifier LEFT OUTPUT terminal strip COMMON screw. Connect another lead from the other terminal of the left speaker to the screw with the number corresponding to the speaker impedance on the LEFT OUTPUT terminal strip. The right channel speaker is connected in the same manner on the RIGHT OUTPUT terminal strip. For stereo or twin channel operation it is not necessary to use the same impedance loudspeaker on each output. Connect each channel for the impedance desired. Full power will be delivered to each properly connected speaker.

When multiple speakers are to be connected to either or both outputs, the combined load impedance must be calculated. The load must be connected to the appropriate impedance tap. Use this table to aid in selecting the correct impedance match:

Load impedance in ohms	Connect for	Load impedance in ohms	Connect for
0.8 to 1.6	1 ohm output	3.2 to 6.4	4 ohm output
1.6 to 3.2	2 ohm output	6.4 and up	8 ohm output

If a load impedance is used that is lower than the output impedance tap, then reduced power and possible distortion

will result. If a load impedance is used that is higher than the output impedance tap, then neither the signal nor the amplifier will be harmed but the power available is limited.

FOR STEREO OR TWIN AMPLIFIER CONSTANT VOLTAGE OPERATION:

For output voltage of 25 volts Connect for 4 ohms

MONOPHONIC OR SINGLE CHANNEL OPERATION

When the MC 2205 is used as a monophonic or single channel power amplifier the two channels are combined to produce output up to 400 watts. The outputs must be tied together at the appropriate load impedance tap. In connecting a load to the MC 2205 for single channel operation connect the common side of the load to the LEFT CHANNEL OUTPUT terminal marked COM., the other lead is connected:

If the speaker or load impedance is	The hot side of the line is connected to	Connect a jumper wire between
0.5 ohm	Left 1	Left 1 and Right 1
1 ohm	Left 2	Left 2 and Right 2
2 ohms	Left 4	Left 4 and Right 4
4 ohms	Left 8	Left 8 and Right 8

Do not connect unequal impedance taps together

If the load impedance is between any of the above figures, select the best impedance match from:

Load impedance in ohms	Connect for	Load impedance in ohms	Connect for
0.4 to 0.8	0.5 ohm output	1.6 to 3.2	2 ohm output
0.8 to 1.6	1 ohm output	3.2 and up	4 ohm output

FOR MONOPHONIC CONSTANT VOLTAGE LINE OPERATION

For output voltage of 25 volts Connected for 2 ohm output (mono)

For multiple speaker operation, run separate leads from the amplifier to the speakers. Should the MODE SWITCH be left in the STEREO position and the output transformers be strapped to a monophonic load, one channel will attempt to drive the other and cause circulating currents and overheating. **Be certain that the MC 2205 is never operated in the stereo mode with the outputs connected for monophonic operations.**

AC POWER

The MC 2205 operates on 120 volts 50/60 Hz. The auxiliary AC OUTLET on the MC 2205 is not fused or switched.

Wire Gauge	MAXIMUM WIRE LENGTHS			
	For 4 Ohm Load		For 8 Ohm Load	
	Feet	Meters	Feet	Meters
22	6	1.83	12	3.66
20	10	3.05	20	6.10
18	15	4.57	30	9.14
16	25	7.62	50	15.24
14	40	12.19	80	24.38
12	60	18.29	120	36.58
10	100	30.48	200	60.96

These wire lengths represent the length of a two conductor cable having a resistance equal to 5% of the speakers impedance. Use of smaller wire sizes will produce more resistance which causes more power loss and less loudspeaker damping.

Stereophonic Connections

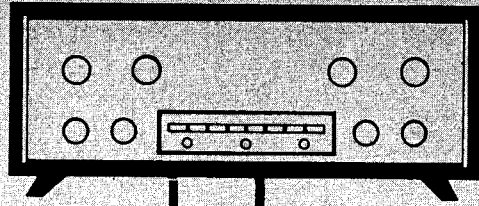

PROGRAM SOURCE

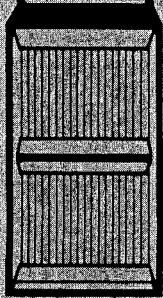
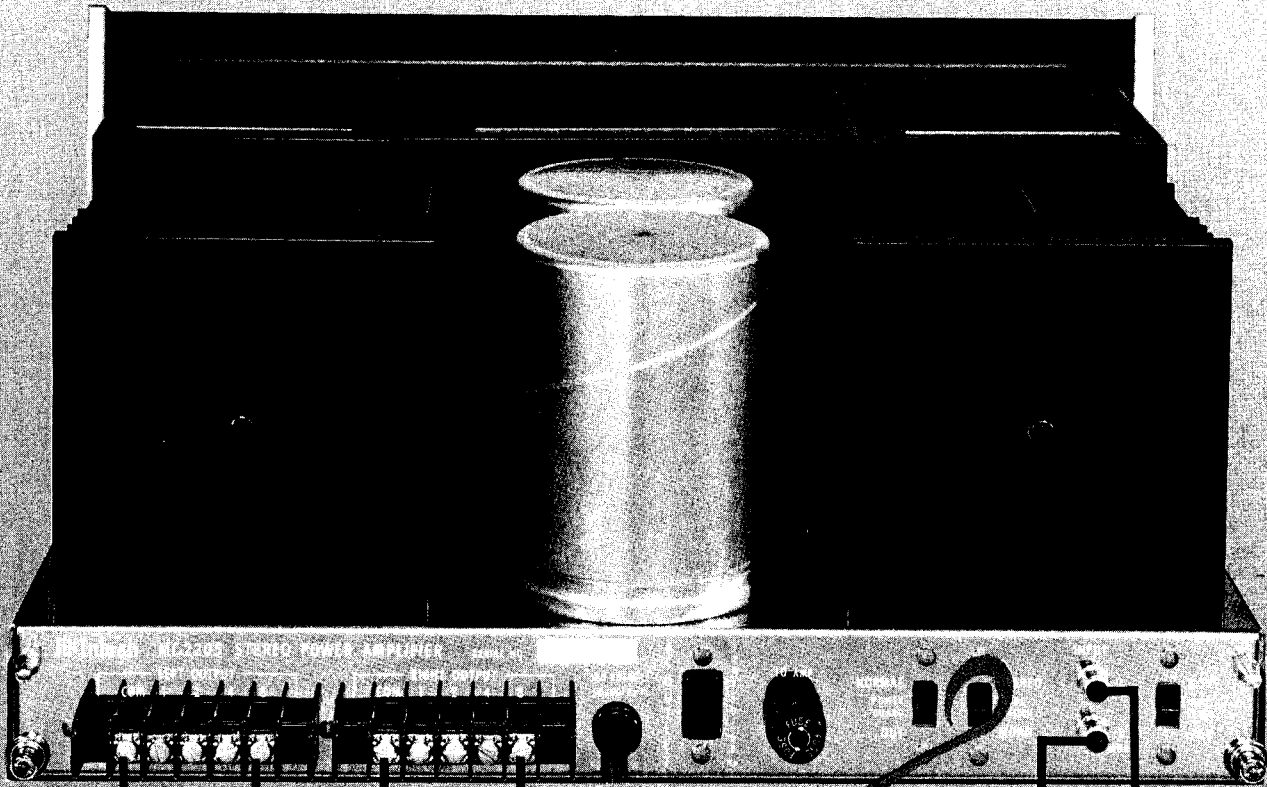

LEFT SPEAKER

MUST BE IN STEREO POSITION FOR STEREO PROGRAMS



STEREO

MODE SWITCH

MONO

RIGHT SPEAKER

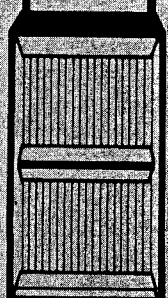

Monophonic Connections

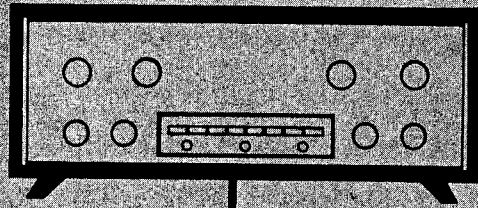

PROGRAM SOURCE

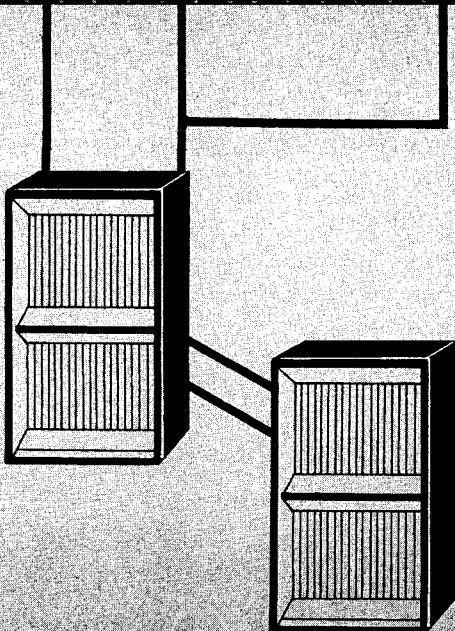
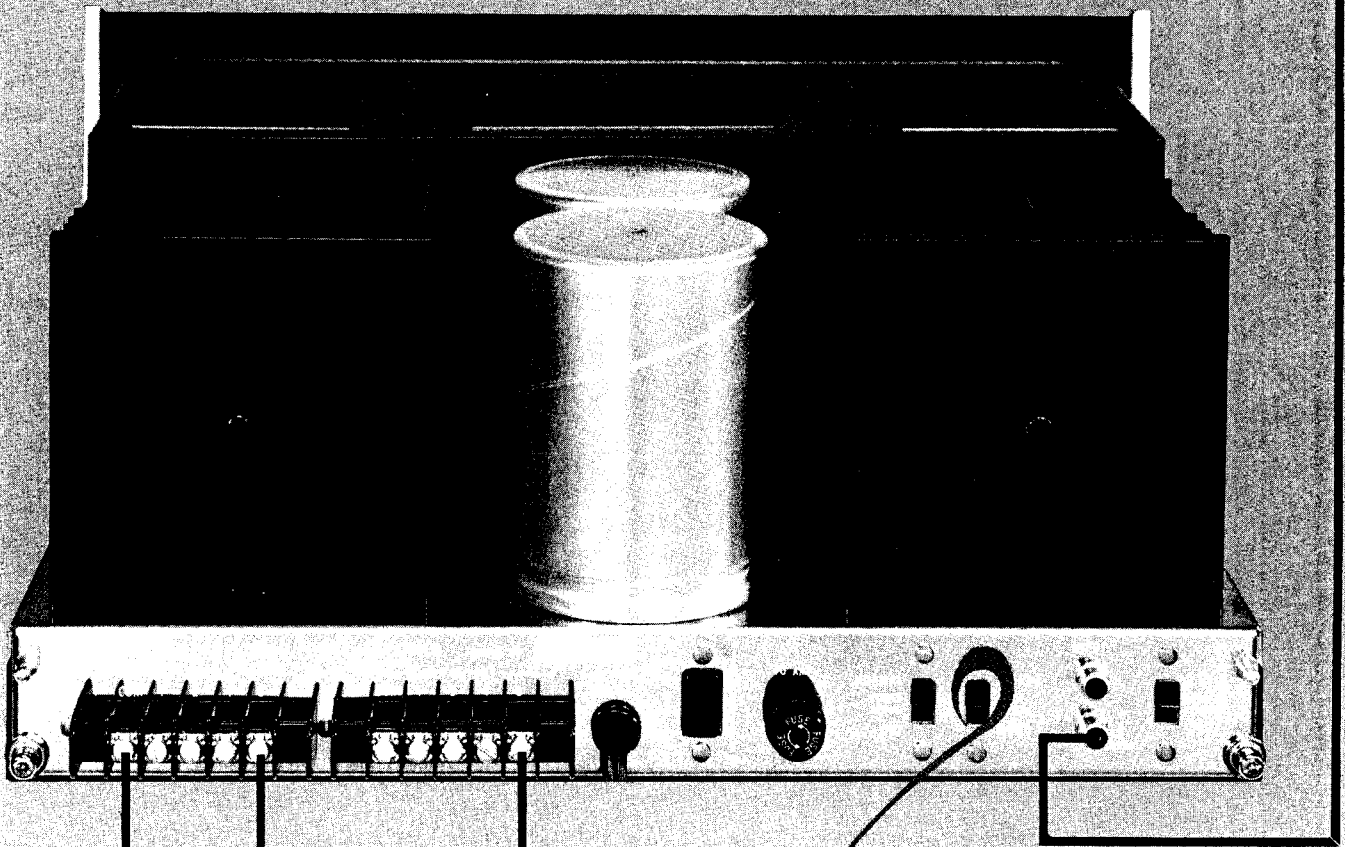

CONNECT FOR MONO USE
ONLY WHEN THE MODE
SWITCH IS IN MONO POSITION

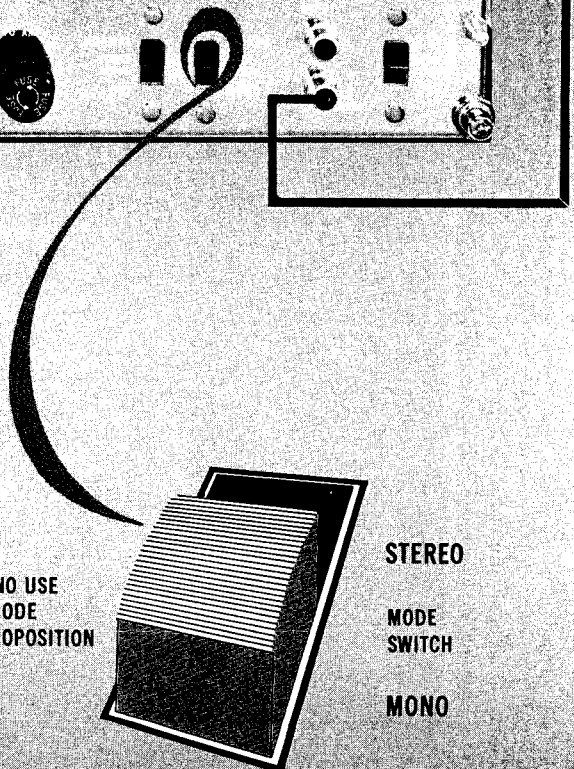

STEREO
MODE
SWITCH
MONO

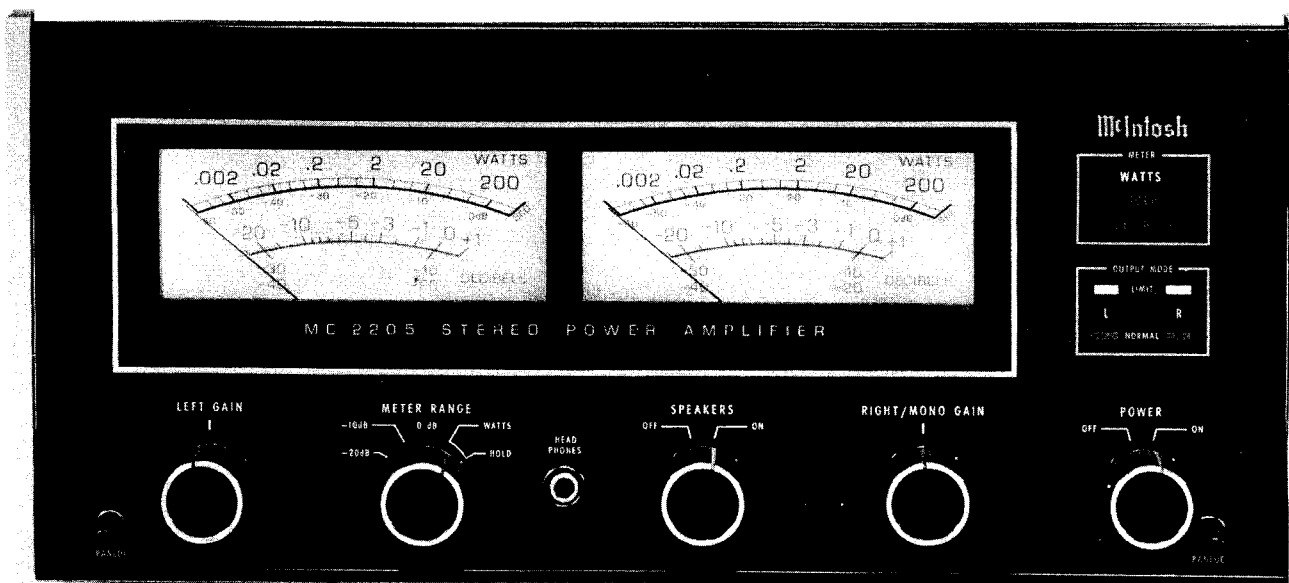

Front Panel Information

METERS

Output power monitor meters indicate the output power of each channel. Each meter has two primary scales: WATTS and DECIBELS. With the METER RANGE switch in one of the decibel (dB) positions, *peak signal* readings are indicated on the lower DECIBEL scale. The meters show peak output of the monitored channel. Ordinary meters lack the capability of indicating the short interval information in a sound wave. The mass of the meter movement is too great to respond to the nearly instantaneous changes in music program material. The short interval information can have a duration as short as half a thousandth of a second. Ordinarily, a meter pointer moving over its scale in such a short time would not be seen. McIntosh has developed circuits that drive the meters to respond to the short interval information in a sound wave to an accuracy of 98%. The electrical pulse that drives the meter pointer is time stretched long enough so that the peak position of the pointer can register in the persistence of vision characteristic of the retina of the human eye.

With the METER RANGE switch in the WATTS positions, direct power in watts is read from the upper watts scale. The meters are calibrated in average watts for a sine wave signal but respond to signal peaks. So, a 200 average watt indication also means 400 instantaneous peak watts. The meters are voltage actuated and indicate power accurately when the amplifier is operated into

rated output load impedances. The illuminated word in the rectangular METER block on the right hand side of the panel indicates which scale is in use.

LEFT GAIN

Use the LEFT GAIN control to adjust the volume in the left channel to the desired listening level. Turn the control clockwise to increase the volume.

RIGHT/MONO GAIN

Use the RIGHT/MONO GAIN control to adjust the volume in the right channel to the desired listening level. Turn the control clockwise to increase the volume.

MONO

With the output of MC 2205 connected for monophonic operation and the rear panel MODE SWITCH in MONO the volume is controlled by the RIGHT/MONO GAIN control only.

METER RANGE

The METER RANGE switch has five positions.

WATTS

In the WATTS position the meter's primary calibration is from .002 watts (two milliwatts), up to 200 watts, the advertised maximum low distortion power output of the MC 2205. The meter's indicated power output is accurate

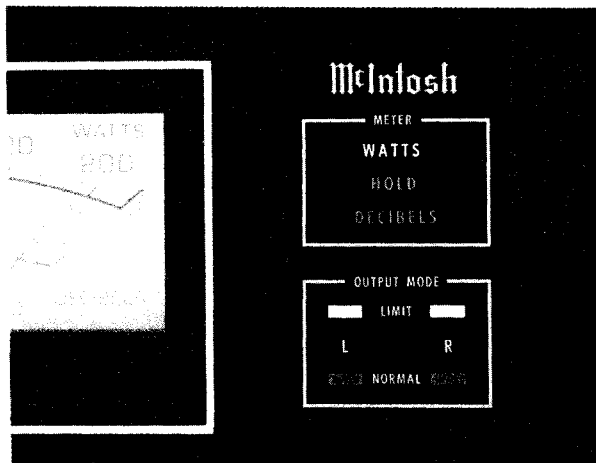

if the load impedance is connected to the matching output transformer tap at the LEFT and RIGHT OUTPUT barrier strip on the rear panel. The meter is calibrated for 500 watts at the right hand end of the meter scale. While the MC 2205 cannot reach this power level continuously, it is possible for short interval peaks to exceed, considerably, the 200 watt continuous rating.

HOLD

In the HOLD position, the meter indicates WATTS and locks to the highest power peak in a sequence of peaks. The meter will be driven to maximum power and electronically held there until a higher peak passes through the amplifier. If no further peaks are reached the meter needle will very slowly return to its rest position (decay rate: 10 dB per minute.) Both WATTS and HOLD will be illuminated in the METER rectangle when the METER RANGE switch is in the HOLD position.

DECIBELS

In the other three positions of the METER RANGE switch the meters will indicate the output of each channel in DECIBELS relative to 200 watts or any other appropriate arbitrarily chosen reference.

- 0 dB In this position of the switch, if the amplifier delivers 200 average watts or 400 peak watts, the meter indicates 0 dB; at 100 average watts the meter indicates -3 dB. If the amplifier is overdriven to +1 dB the indicated output would be 252 watts.
- 10 dB In this position of the switch, if the amplifier delivers 20 average watts, the meter indicates 0 dB; at 10 average watts the meter indicates -3 dB.
- 20 dB In this position of the switch, if the amplifier delivers 2 average watts, the meter indicates 0 dB; at 1 average watt the meter indicates -3 dB.

OUTPUT MODE

The NORMAL (green) and LIMIT (red) indicators are a new McIntosh development. As long as the amplifier operates without overload the NORMAL indicator illuminates. A waveform comparator in the MC 2205 constantly compares the amplifier input and output waveform. Waveform difference of the output wave is converted to a voltage which is used as a control signal to "turn off" the NORMAL indicator and to "turn on" the LIMIT indicator. The LIMIT indicator is on whenever the waveform difference exceeds 0.5%. Generally, these waveform differences are the result of applying voltages at the input in excess of its rating. Because the limit indicator circuit can show an overload condition as short as one cycle of a 20,000 Hz signal a holding circuit keeps the red indicator on long enough for the eye to see. If the amplifier output is mismatched or shorted, the LIMIT indicator will illuminate when the meters indicate less than rated output.

HEADPHONES

The output of the front panel HEADPHONE jack has been designed to feed low impedance dynamic stereo headphones. Electrostatic headphones generally require higher power than dynamic headphones. Connect them to the LEFT and RIGHT MAIN SPEAKER contacts on the back of the MC 2205. Plug dynamic headphones into the front panel HEADPHONE jack. Adjust the front panel LEFT GAIN and RIGHT/MONO GAIN control for comfortable headphone listening.

The HEADPHONE output is not affected by the SPEAKER switch.

SPEAKERS

OFF: The loudspeakers are turned off when the SPEAKER switch is in the OFF position. You can listen to headphones in private.

THE SPEAKER SWITCH MUST BE IN THE "ON" POSITION TO HEAR MUSIC FROM THE LOUDSPEAKERS.

ON: Music will be heard through the loudspeakers. Use this as the normal listening position.

POWER

The power switch turns the MC 2205 ON or OFF. The switch does not control the power outlet on the back panel. If you wish to control the AC power from a preamplifier control center leave the switch in the ON position. Be sure the AC cord of the MC 2205 is plugged into the controlled outlets on the rear of the preamplifier control center.

OFF: In the OFF position the AC power to the amplifier is turned off.

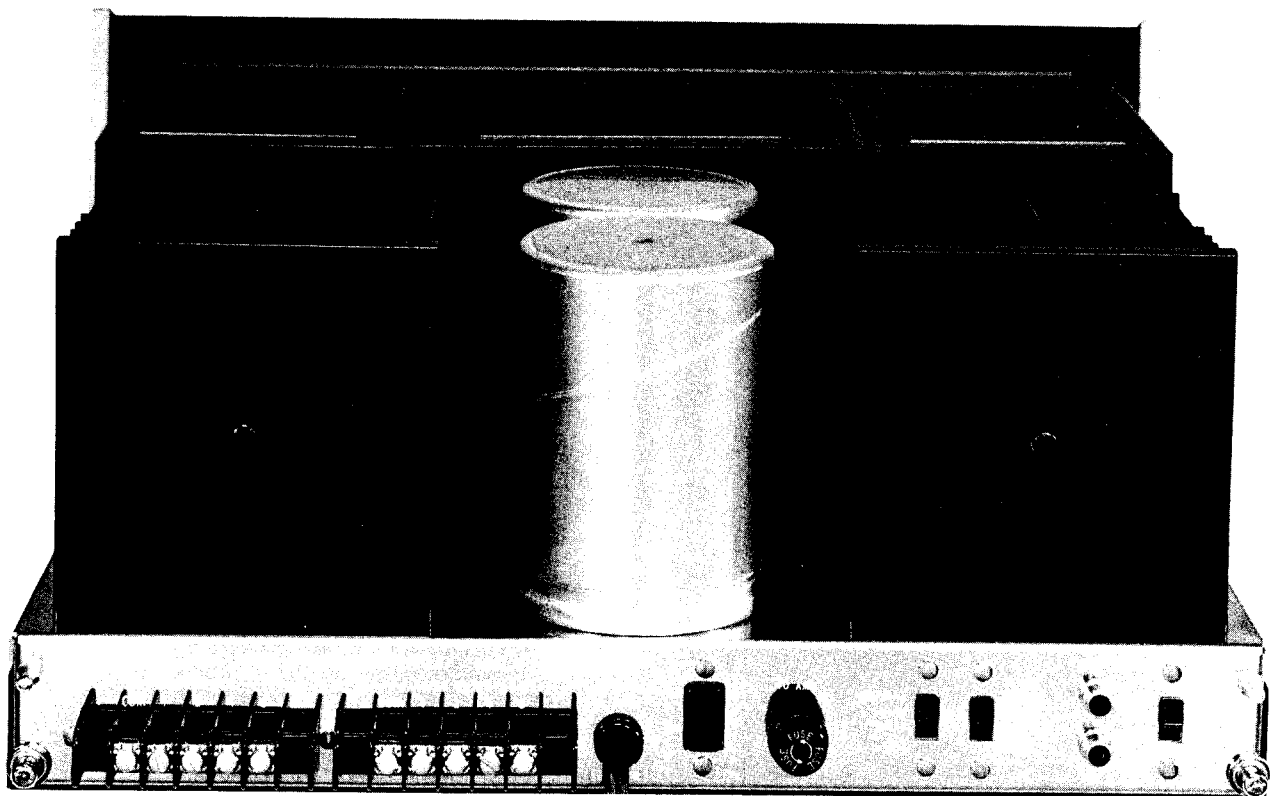

Rear Panel Information

LEFT and RIGHT OUTPUT

For stereo operation, output impedances of 1, 2, 4 and 8 ohms have been provided on a secure, screw type barrier strip. For monophonic operation proper interconnection provides 0.5, 1, 2 and 4 ohms from the same barrier strips.

POWER GUARD

Amplifiers are capable of delivering large quantities of power when they are driven to clipping. Clipping is caused when the amplifier is asked to produce more power output than it can deliver with low distortion. A clipped amplifier can have more than 40% harmonic distortion. The extra energy content of the clipped signal will damage most speakers. A new McIntosh advancement helps to protect your speaker from this kind of damage. The MC 2205 has a built in "waveform comparator" that compares the wave shape of the input signal with the output signal. If the non-linearity between the two signals exceeds 0.5% a front panel signal illuminates in red (LIMIT). With the POWER GUARD switch in the NORMAL position, 1.0% distortion will cause the POWER GUARD circuit to operate. The POWER GUARD circuit limits the input dynamically so that the amplifier cannot be overdriven which eliminates amplifier output clipping.

MODE SWITCH

The MC 2205 can be used in these different manners: stereo (or as a twin amplifier) and mono. Because of the excellent channel separation of the MC 2205, it can fulfill all of these functions. When the outputs are properly con-

nected the MODE switch is used to select the method of operation desired.

INPUT

In the stereo or twin amplifier mode of operation both input jacks accept signal. In the mono mode of operation the Left channel input jack is disconnected and only the Right (MONO) channel input jack accepts signal.

INPUT LEVEL

The input sensitivity of the MC 2205 is 0.75 volts or 2.5 V depending on the position of the INPUT LEVEL switch. With indicated voltage applied, the amplifier will deliver its rated power. All McIntosh preamplifiers have been designed to deliver 2.5 volts output with rated input. For the best signal to noise ratio when using McIntosh source equipment, always have the INPUT LEVEL switch in the 2.5 V position and the front panel LEFT and RIGHT/MONO GAIN controls in the fully clockwise position. If more gain is desired the 0.75 V position may be used. For source equipment other than McIntosh set the switch in the position nearest to the stated output rating of the source equipment.

AC POWER

The MC 2205 is rated for 120 volts, 50/60 hertz. It uses 50 watts when there is no signal output and 750 watts with both channels delivering rated power. A 10 ampere fuse protects the MC 2205 electrically. An auxiliary AC power outlet has been provided. The auxiliary outlet is neither fused nor switched.

Performance Limits and Ratings

PERFORMANCE GUARANTEE

Performance Limits are the maximum deviation from perfection permitted for a McIntosh instrument. We promise you that the MC 2205 you buy must be capable of performance at or exceeding these limits or you get your money back. McIntosh is the only manufacturer that makes this guarantee.

PERFORMANCE

McIntosh audio power ratings are in accordance with the Federal Trade Commission Regulation of November 4, 1974 concerning power output claims for amplifiers used in home entertainment products.

POWER OUTPUT

STEREO

200 watts minimum sine wave continuous average power output, per channel, both channels operating into 1 ohm, 2 ohms, 4 ohms, or 8 ohms load impedance, which is:

- 14.1 volts RMS across 1 ohm
- 20.0 volts RMS across 2 ohms
- 28.3 volts RMS across 4 ohms
- 40.0 volts RMS across 8 ohms

MONO

400 watts minimum sine wave continuous average power output into 0.5 ohm, 1 ohm, 2 ohms, or 4 ohms load impedance, which is:

- 14.1 volts RMS across 0.5 ohm
- 20.0 volts RMS across 1 ohm
- 28.3 volts RMS across 2 ohms
- 40.0 volts RMS across 4 ohms

OUTPUT LOAD IMPEDANCE

STEREO

1 ohm, 2 ohms, 4 ohms, and 8 ohms; separate terminals are provided for each output

MONO

0.5 ohm, 1 ohm, 2 ohms, and 4 ohms; obtained by connecting together the appropriate terminals of both channels

RATED POWER BAND

20 Hz to 20,000 Hz

TOTAL HARMONIC DISTORTION

STEREO

0.1% maximum harmonic distortion at any power level from 250 milliwatts to 200 watts per channel from 20 Hz to 20,000 Hz, both channels operating

MONO

0.1% maximum harmonic distortion at any power level from 250 milliwatts to 400 watts from 20 Hz to 20,000 Hz

INTERMODULATION DISTORTION

STEREO

0.1% maximum if instantaneous peak power output is 400 watts or less per channel with both channels operating for any combination of frequencies, 20 Hz to 20,000 Hz

MONO

0.1% maximum if instantaneous peak power output is 800 watts or less for any combination of frequencies, 20 Hz to 20,000 Hz

FREQUENCY RESPONSE (at one watt output)

20 Hz to 20,000 Hz, +0 -0.25 dB
10 Hz to 100,000 Hz +0 -3.0 dB

NOISE AND HUM

95 dB below rated output

RATINGS

OUTPUT VOLTAGES

25 volts for distribution lines

DAMPING FACTOR

STEREO

16 at 1 ohm output, 50 at 2 ohms output, 30 at 4 ohms output, 16 at 8 ohms output

MONO

16 at 0.5 ohms, 50 at 1 ohm, 30 at 2 ohms, and 16 at 4 ohms output

INPUT IMPEDANCE

100,000 ohms

INPUT SENSITIVITY

Switchable: 0.75 volt or 2.5 volts—Level control provided for higher input voltages

GENERAL INFORMATION

POWER REQUIREMENTS

120 volts 50/60 Hz, 50 watts at zero signal output, 750 watts at rated output

SEMICONDUCTOR COMPLEMENT

49 silicon transistors
45 silicon rectifiers and diodes
8 integrated circuits

MECHANICAL INFORMATION

SIZE

Front panel measures 16 3/16 inches wide (41.12 cm) by 7 1/8 inches high (18.1 cm). Chassis measures 15 inches wide (38.1 cm) by 6 9/16 inches high (16.67 cm) by 14 1/2 inches deep (36.83 cm), including connectors. Knob clearance required is 1 1/2 inches (3.81 cm) in front of mounting panel

FINISH

Front panel is anodized gold and black with special gold/teal nomenclature illumination. Chassis is chrome and black

WEIGHT

85 pounds (38.6 kg) net, 97 pounds (44.0 kg) in shipping carton

Performance Charts

Per Channel Both Channels Operating

OUTPUT SIGNAL WAVEFORM SHOWING ACTION OF POWER GUARD TO ELIMINATE OUTPUT SIGNAL CLIPPING. AMPLIFIER INPUT IS OVERDRIVEN BY 20 dB FOR BOTH OSCILLOGRAM TRACES.

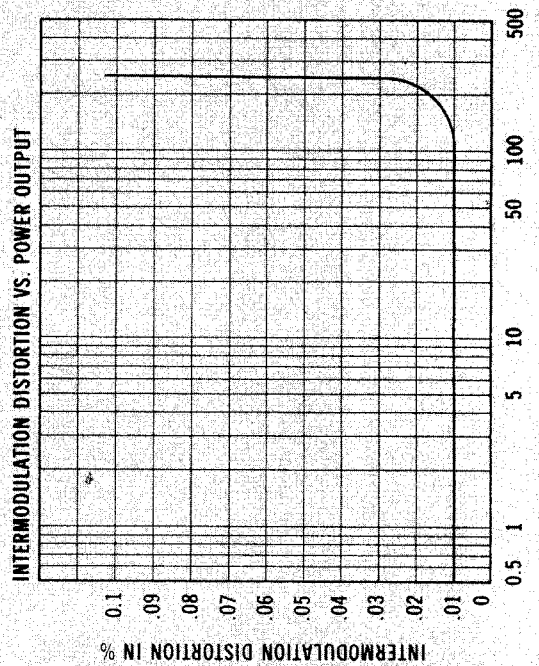
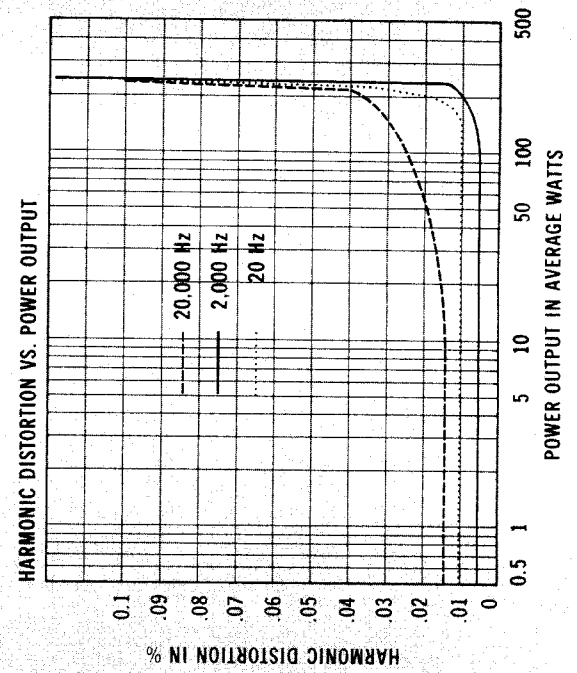
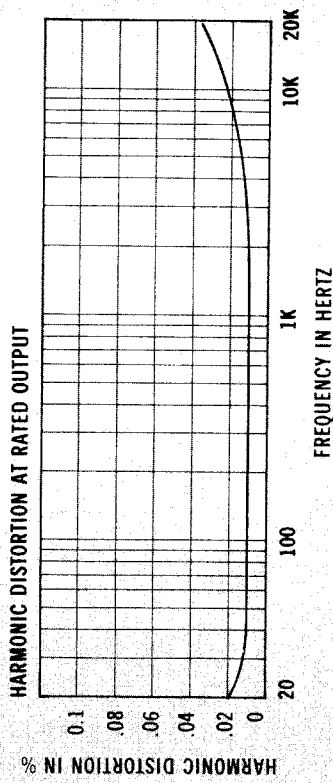
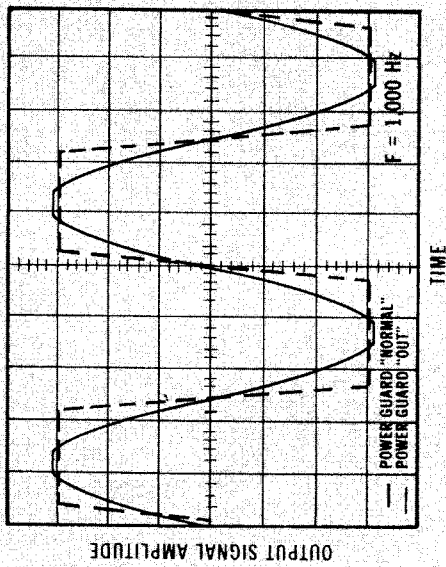

FREQUENCY RESPONSE AT 1 WATT OUTPUT

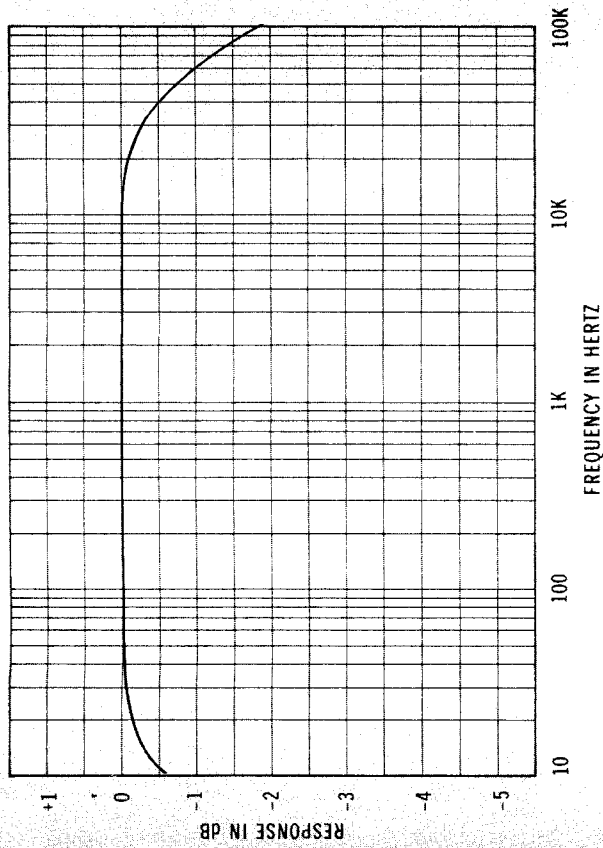

POWER BANDWIDTH AT 0.1% THD

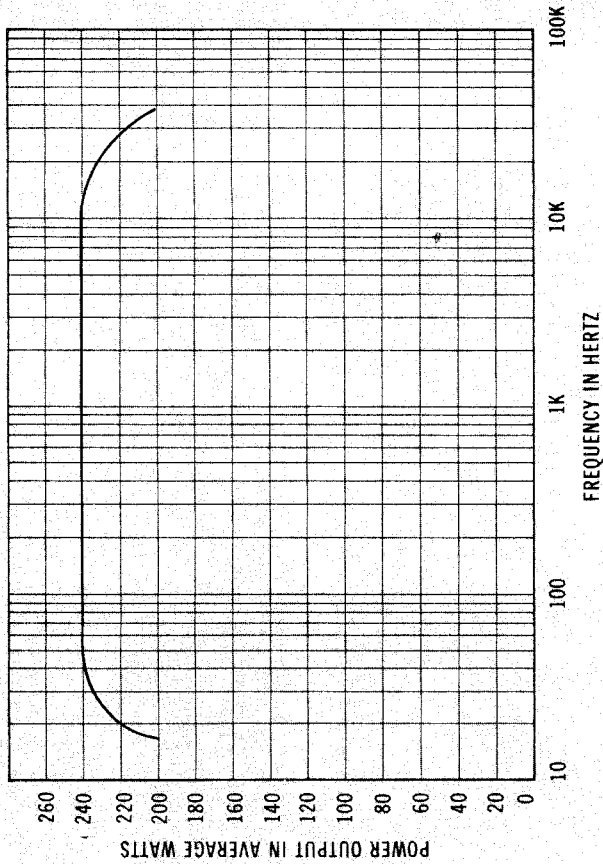

METER RESPONSE TO A SINGLE 500 MICRO SECOND TONE BURST

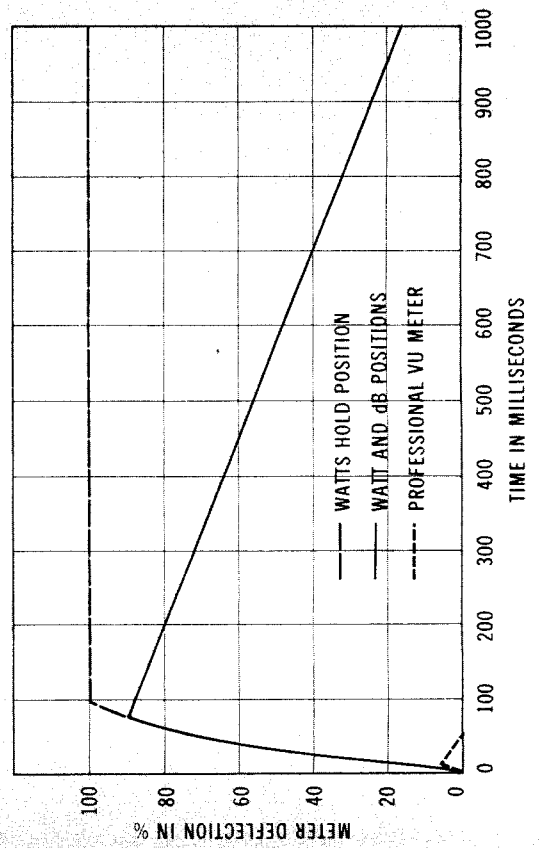

METER RESPONSE TO A SINGLE 300 MILLISECOND TONE BURST

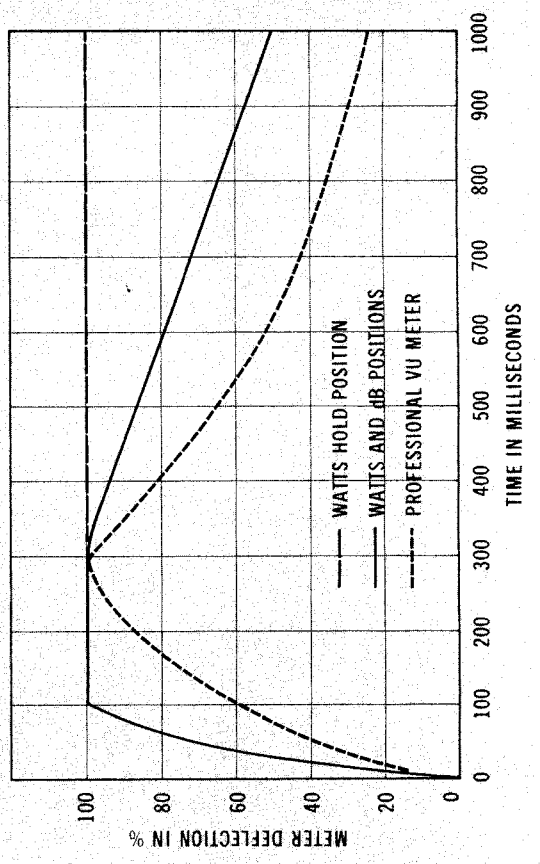

Technical Description

INPUT AMPLIFIER

Separate input amplifiers are used for the right and left channels. Each input amplifier is a two transistor feedback amplifier which has unity gain. They are used to provide high input impedance and low output impedance for driving the power amplifier sections. In addition, impedance matching is provided for the POWER GUARD system input attenuator.

When the MODE selector is switched to MONO, only the right channel input, GAIN control, POWER GUARD attenuator, and input amplifier is used to drive both power amplifiers.

POWER AMPLIFIER

There are two identical power amplifier sections. At the input to each power amplifier is a monolithic differential transistor selected for low noise. The monolithic design yields closely matched transistors for low distortion. The input and the feedback signals are applied to this differential amplifier. The second stage is a class A voltage amplifier using a single transistor with feedback.

The predriver, driver, and output sections are fully complimentary and have high efficiency and negligible distortion. The predriver is a complimentary transistor pair biased to nearly class A operation for low crossover distortion. Bias is supplied by a transistor which serves as a temperature tracking circuit so the predriver is properly biased regardless of temperature. The predriver has a generous amount of emitter degeneration for low distortion.

Another complimentary pair of power transistors biased for class AB operation make up the output driver stages. Their bias is developed across a thermistor which holds the bias current stable regardless of temperature.

The output stage consists of 6 rugged complimentary power transistors connected in single ended push-pull parallel. This stage is connected as a balanced emitter follower which allows great stability and low distortion. Due to a unique arrangement of the output bias network, the output transistors are operated class B free of crossover distortion. Heat is not produced by these transistors when there is no output. The bias network for the output stage is temperature compensated assuring class B operation at any temperature or power level.

The output transistors and drivers are mounted on a generous sized black anodized aluminum heat sinks. The free flow of room temperature air that passes through the oversized heat sinks provides the cooling necessary for the long life of components.

The MC 2205 has transient free turn on and turn off characteristics. The output of the amplifier is switched by a heavy duty relay to the output auto transformer. The relay is driven by a transistor switch. The control signal to this

transistor is derived from a long time constant capacitor charging network. The switch turns on the relay approximately two seconds after the MC 2205 is turned on. The same circuit has a short turn-off time constant which turns off the relay before the amplifier's main power supply has had a chance to drop. The relay is also controlled by the SPEAKER switch. The output signal is fed through a matching network to the front panel HEADPHONE jack. The HEADPHONE output is designed to feed low impedance dynamic stereo headphones. The signal is always available at the HEADPHONE jacks. The HEADPHONE output is not switched.

The amplifier output signal is fed to the output terminals through the autotransformer. The McIntosh designed interleaved multifilar wound autotransformer is used to properly match the amplifier to any output impedance tap. The MC 2205 will deliver full power over the entire audio frequency range at any of these impedances. The autotransformer also protects speakers from damage in the event of amplifier failure. Should a direct current component appear in the output it is shunted by the autotransformer and cannot damage the speaker.

The McIntosh patented Sentry Monitoring circuit constantly monitors the output signal and instantly reacts to prevent overload of the output transistors. At signal levels up to rated output this circuit has high impedance and has no effect upon the output. If the power output exceeds design maximum, the Sentry Monitoring circuit operates to limit the signal to the output transistors. In the event of a short circuit across the amplifier output or severe impedance mismatch the Sentry Monitoring circuit will protect the output transistors from failure. Both positive and negative halves of the output signal are monitored independently.

LIMIT INDICATOR AND POWER GUARD

The front panel NORMAL (green) and LIMIT (red) indicators in the OUTPUT MODE rectangle are activated by a newly designed McIntosh circuit. The MC 2205 has a built in "waveform comparator." The waveform comparator electrically compares the amplifier's output waveform with the input waveform. Should the waveform differences reach 0.5%, the red LIMIT indicator on the front panel is turned on and the NORMAL indicator is turned off. If the differences increase to 1% the POWER GUARD circuit is activated. POWER GUARD provides an unusual margin of safety for loudspeakers by the prevention of amplifier clipping yet permits the amplifier to deliver designed maximum power.

The input waveform and the output waveform are compared in an integrated circuit differential amplifier. Any differences, due to distortion of the output waveform, are converted to a control voltage. This control voltage is applied differentially to a high gain operational amplifier

where it is amplified about 100 times. The amplified control voltage is detected by a full wave bridge rectifier then enters a Schmidt trigger which is programmed to sequence the front panel indicators from NORMAL (green) to LIMIT (red) at a preset distortion level. Also built into the trigger circuit is a timing capacitor which holds the LIMIT indicator on long enough to be visible even when the duration of the overload is much shorter. The LIMIT indicator will be illuminated for an overload condition as short as one cycle of a signal at 20,000 Hz. If the amplifier output is mismatched or shorted the LIMIT indicator will be turned on when the meters indicate less than 200 watts.

The same control voltage used to activate the LIMIT indicator also actuates the POWER GUARD system. If the control voltage is greater than is needed to illuminate the LIMIT indication then the POWER GUARD begins operating. The control voltage is used to operate a light emitting diode/light dependent resistor (LDR) network. The LDR is part of an attenuator between the volume control and the input amplifier. The input to the power amplifier can be attenuated to as little as one tenth, if necessary, in order to maintain low distortion in the event of excessive input signal.

The POWER GUARD circuit is activated when the rear panel switch is in the NORMAL position. POWER GUARD protection is disabled in the OUT position. The LIMIT indicator operates regardless of the position of the POWER GUARD switch.

METER CIRCUIT

The meter circuit has three basic sections: the logarithmic amplifier, full wave rectifier, and DC amplifier. In the WATTS ranges, the logarithmic amplifier is used. In the DECIBEL ranges, the signal goes directly to the full wave rectifiers through an attenuator which is selected by the METER RANGE switch.

The logarithmic amplifier consists of a high gain operational amplifier with a bipolar connected silicon diode pair as feedback elements. These diodes have a uniform logarithmic characteristic over an 80 dB range. Only 60 dB of the logarithmic portion of this range has been used in the MC 2205. A second diode pair follows the operational amplifier for compensation of diode contact potential. Since the compensation circuit has a temperature coefficient, thermistors are used to stabilize the logarithmic output with temperature changes.

The full wave rectifier circuit uses a pair of operational amplifiers with silicon diode feedback networks. These amplified diode circuits have nearly perfect rectification characteristics. One rectifier detects only positive signals. The other responds only to negative signals and produces a positive output. The outputs of the detectors are combined in a diode gate so the highest signal, either positive or negative, is the one that is indicated by the meters. These gate diodes charge a low leakage capacitor which attains and holds a charge during signal peaks. The operational amplifier detectors provide a large amount of current so the capacitor will charge suddenly. Connected to the peak holding capacitor is a diode clamp to prevent the charge on the capacitor from exceeding that which is required for a full scale meter reading. This prevents meter damage that might result from slamming the meter end stop. The charge on the peak holding capacitor is amplified in a two transistor DC feedback amplifier which is used to drive the meter. From the output of this amplifier there is a DC feedback network that feeds the detectors to assure excellent overall linearity and frequency response. The current drive to the meters has a peaking capacitor to accelerate the upscale response of the meter needle. The meters also have a parallel shunt resistor to correctly damp their action. In the WATTS mode the discharge of the peak holding capacitor is controlled by a resistor current source. In WATTS HOLD, the resistor is disconnected so the peak reading is retained. The rate of decay is 10 dB per minute.

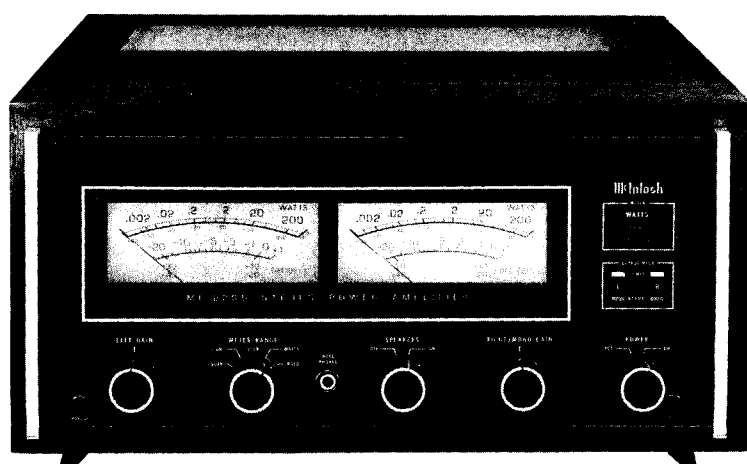

Block Diagram

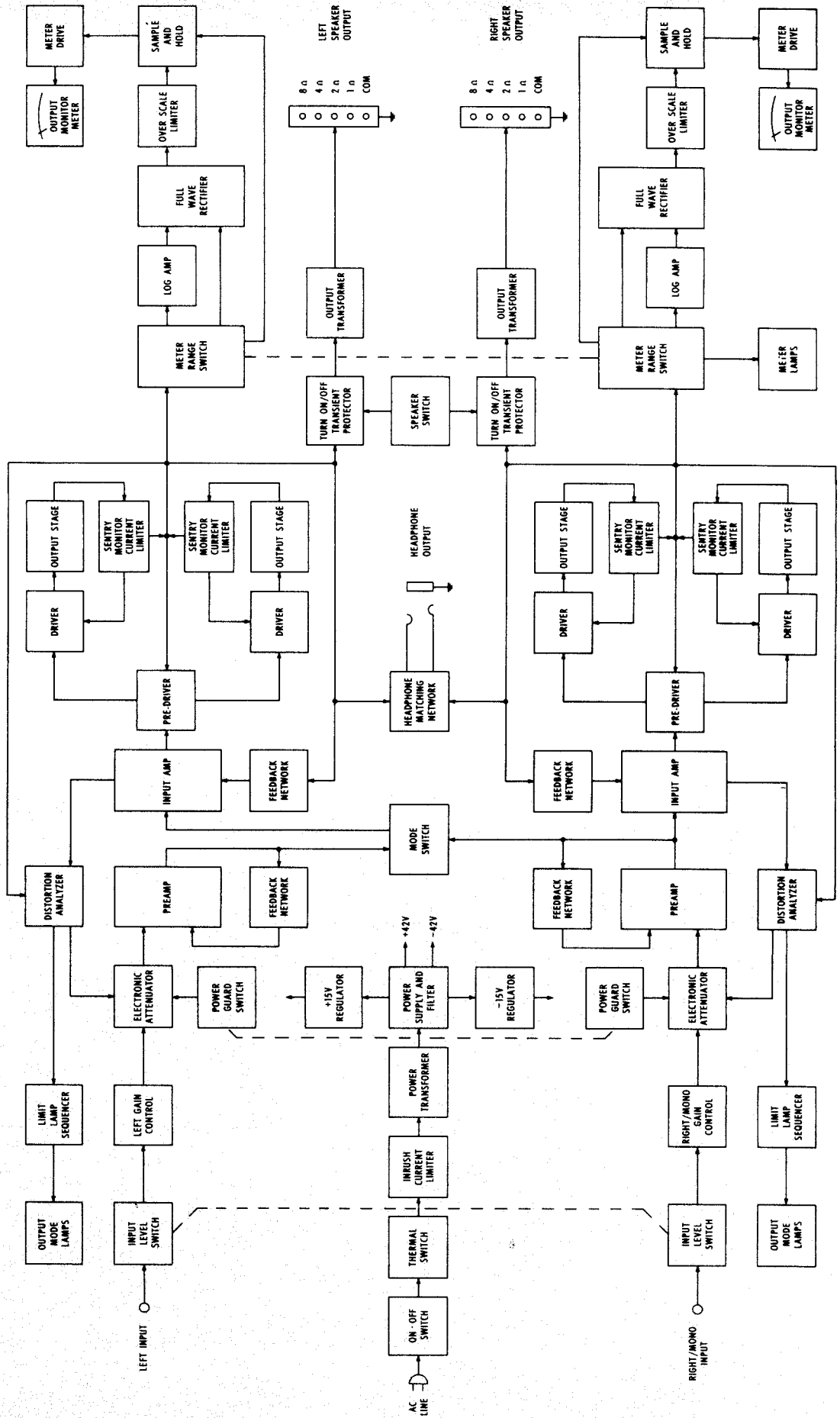

McIntosh

McINTOSH LABORATORY INC.

2 CHAMBERS ST., BINGHAMTON, N. Y. 13903

607-723-3512

Design subject to change without notice.

Printed in U.S.A.

038-960