



Stereo Power Amplifier



MC275 Owner's Manual

The lightning flash with arrowhead, within an equilateral triangle, is intended to alert the user to the presence of uninsulated “dangerous voltage” within the product’s enclosure that may be of sufficient magnitude to constitute a risk of electric shock to persons.



AVIS RISQUE DE CHOC ELECTRIQUE - NE PAS OUVRIR.

The exclamation point within an equilateral triangle is intended to alert the user to the presence of important operating and maintenance (servicing) instructions in the literature accompanying the appliance.

WARNING - TO REDUCE RISK OF FIRE OR ELECTRICAL SHOCK, DO NOT EXPOSE THIS EQUIPMENT TO RAIN OR MOISTURE.

NO USER-SERVICEABLE PARTS INSIDE. REFER SERVICING TO QUALIFIED PERSONNEL.

To prevent the risk of electric shock, do not remove cover or back. No user-serviceable parts inside.

IMPORTANT SAFETY INSTRUCTIONS!

PLEASE READ THEM BEFORE OPERATING THIS EQUIPMENT.

1. Read these instructions.
2. Keep these instructions.
3. Heed all warnings.
4. Follow all instructions.
5. Do not use this apparatus near water.
6. Clean only with a dry cloth.
7. Do not block any ventilation openings. Install in accordance with the manufacturer’s instructions.
8. Do not install near any heat sources such as radiators, heat registers, stoves, or other apparatus (including amplifiers) that produce heat.
9. Do not defeat the safety purpose of the polarized or grounding-type plug. A polarized plug has two blades with one wider than the other. A grounding type plug has two blades and a third grounding prong. The wide blade or the third prong are provided for your safety. If the provided plug does not fit into your outlet, consult an electrician for replacement of the obsolete outlet.
10. Protect the power cord from being walked on or pinched particularly at plugs, convenience receptacles, and the point where they exit from the apparatus.
11. Only use attachments/accessories specified by the manufacturer.
12. Use only with the cart, stand, tripod, bracket, or table specified by the manufacturer, or sold with the apparatus. When a cart is used, use caution when moving the cart/apparatus combination to avoid injury from tip-over. 
13. Unplug this apparatus during lightning storms or when unused for long periods of time.
14. Refer all servicing to qualified service personnel. Servicing is required when the apparatus has been damaged in any way, such as power-supply cord or plug is damaged, liquid has been spilled or objects have fallen into the apparatus, the apparatus has been exposed to rain or moisture, does not operate normally, or has been dropped.
15. Do not expose this equipment to dripping or splashing and ensure that no objects filled with liquids, such as vases, are placed on the equipment.
16. To completely disconnect this equipment from the a.c. mains, disconnect the power supply cord plug from the a.c. receptacle.
17. The mains plug of the power supply cord shall remain readily operable.
18. Do not expose batteries to excessive heat such as sunshine, fire or the like.

Thank You

Your decision to own this McIntosh MC275 Stereo Power Amplifier ranks you at the very top among discriminating music listeners. You now have “The Best.” The McIntosh dedication to “Quality,” is assurance that you will receive many years of musical enjoyment from this unit.

Please take a short time to read the information in this manual. We want you to be as familiar as possible with all the features and functions of your new McIntosh.

Please Take A Moment

The serial number, purchase date and McIntosh Dealer name are important to you for possible insurance claim or future service. The spaces below have been provided for you to record that information:

Serial Number: _____

Purchase Date: _____

Dealer Name: _____

Technical Assistance

If at any time you have questions about your McIntosh product, contact your McIntosh Dealer who is familiar with your McIntosh equipment and any other brands that may be part of your system. If you or your Dealer wish additional help concerning a suspected problem, you can receive technical assistance for all McIntosh products at:

McIntosh Laboratory, Inc.
2 Chambers Street
Binghamton, New York 13903
Phone: 607-723-1545
Fax: 607-724-0549

Customer Service

If it is determined that your McIntosh product is in need of repair, you can return it to your Dealer. You can also return it to the McIntosh Laboratory Service Department. For assistance on factory repair return procedure, contact the McIntosh Service Department at:

McIntosh Laboratory, Inc.
2 Chambers Street
Binghamton, New York 13903
Phone: 607-723-3515
Fax: 607-723-1917

Copyright 2006 © by McIntosh Laboratory, Inc.

Table of Contents

Safety Instructions.....	2
Thank You and Please Take a Moment	3
Technical Assistance and Customer Service	3
Table of Contents	3
Important Information.....	3
Connector Information	4
Introduction	4
Performance Features.....	4
Dimensions	5
Installation of Tubes and Tube Cover.....	6
Location and Ventilation	7
Connections:	
Left Side Panel Connections	8
Right Side Panel Connection and Fuse Holder	9
How to Connect for Stereo	10
How to Connect for Mono Parallel.....	11
Left Side Panel Controls and Switches.....	12
Operation:	
How to Operate.....	13
Additional Information:	
Specifications	14
Packing Instructions	15

General Information

- 1. Caution: To prevent electrical shock make sure that the AC POWER CORD IS NOT CONNECTED TO THE MC275 when inserting or removing Vacuum Tubes, as there are hazardous voltages present at the pins of the Tube Sockets.**
2. When Vacuum Tubes are installed or removed make sure to reattach the Tube Cover to the MC275 Chassis.
3. If the MC275 has been On, please allow the Hot Vacuum Tubes to cool first before removing them.
4. For additional connection information, refer to the owner’s manual(s) for any component(s) connected to the MC275.
5. The Main AC Power going to the MC275 and any other McIntosh Component(s) should not be applied until all the system components are connected together. Failure to do so could result in malfunctioning of some or all of the system’s normal operations.

Connector and Cable Information

XLR Connectors

Below is the Pin configuration for the XLR Balanced Input Connectors on the MC275. Refer to the diagram for connection:

- PIN 1: Shield/Ground
- PIN 2: + Output
- PIN 3: - Output

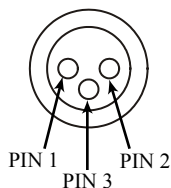

Introduction

Now you can take advantage of traditional McIntosh standards of excellence in the MC275 Stereo Power Amplifier. Two 75 watt output channels will drive any high quality Loudspeaker System to its ultimate performance. The MC275 reproduction is sonically transparent and absolutely accurate. The McIntosh Sound is “The Sound of the Music Itself.”

Performance Features

• Power Output

The MC275 consists of two separate power amplifier channels, each capable of 75 watts into 4, 8 or 16 ohm Loudspeakers in stereo. It may also be operated in mono at 150 watts into 2, 4, or 8 ohm Loudspeakers.

• Bifilar Wound Transformers and Output Circuit

The Power Output Sections utilize the famous McIntosh Patented Unity Coupled Circuit with a Bifilar Wound Output Transformer for low distortion, extended frequency response and cool operating output tubes.

• Balanced and Unbalanced Inputs

Balanced connections guard against induced noise and allow long cable runs without compromising sound quality.

• Gold Plated Connectors and Tube Socket Contacts

Gold Plated Input Jacks and Output Binding Posts provide trouble free connections. Ceramic tube sockets with gold plated contacts provide protection from atmospheric contamination. Output Tube Sockets include Air-Pipe cooling at their bases.

• Super Mirror Chassis Finish

The famous McIntosh Stainless Steel Chassis with Super Mirror Finish ensures the pristine beauty of the MC275 will be retained for many years.

Dimensions

The following dimensions can assist in determining the best location for your MC275. There is additional information on page 7 pertaining to installing the MC275 into cabinets.

Front View of the MC275

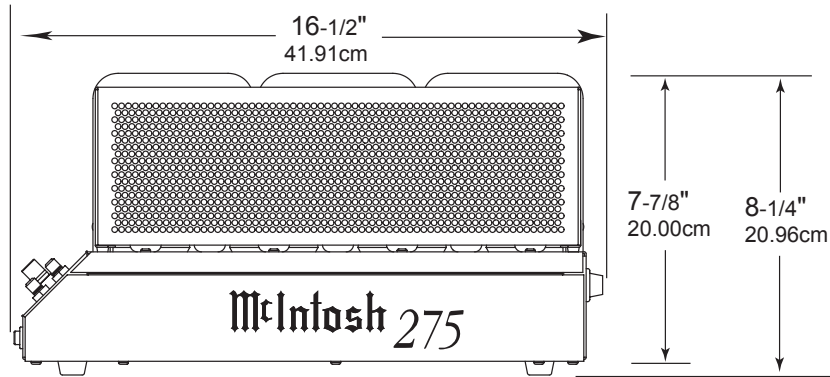

Top View of the MC275

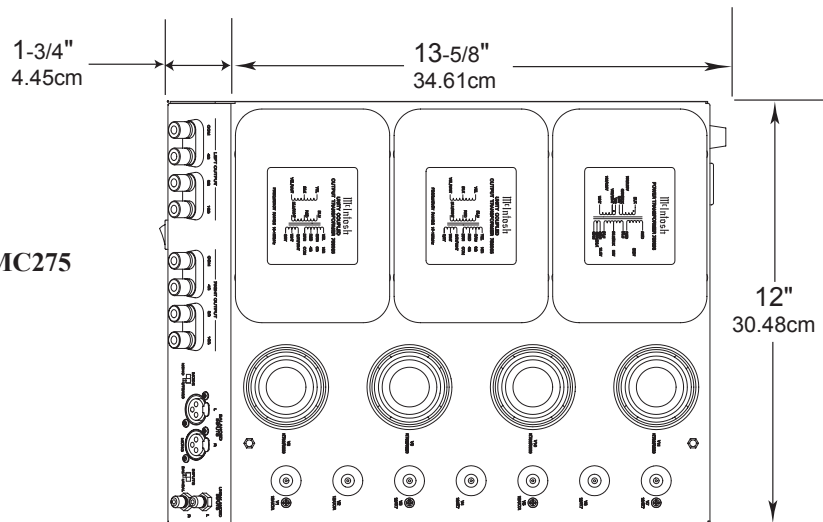

Left Side View of the MC275

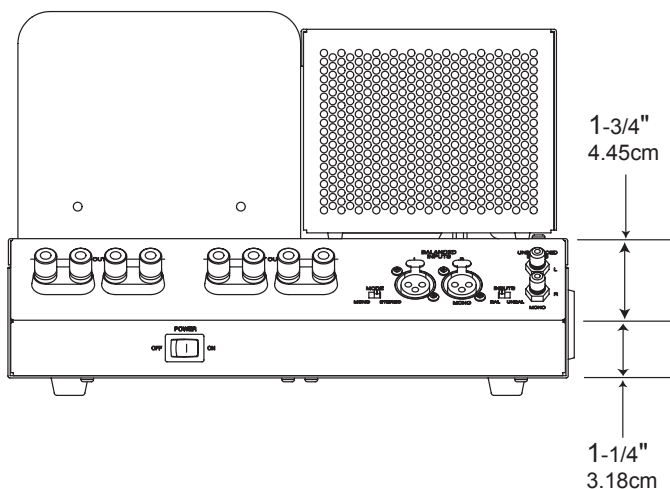

Right Side View of the MC275

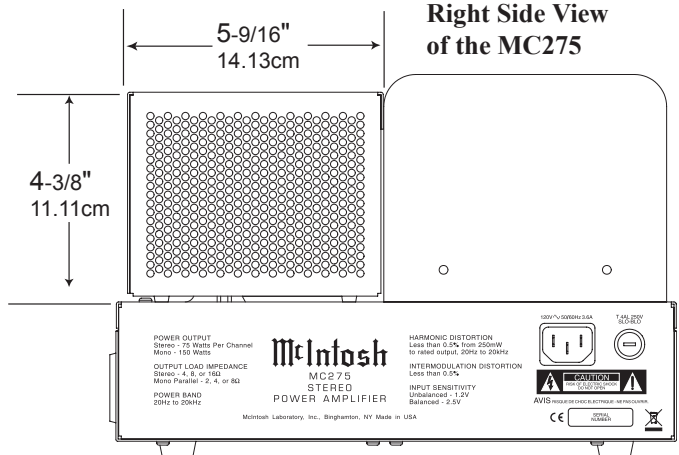

Installation of Tubes and Tube Cover

Caution: To prevent electrical shock make sure that the AC POWER CORD IS NOT CONNECTED TO THE MC275 when inserting or removing Tubes, as there are hazardous voltages present at the pins of the Tube Sockets.

Your MC275 has gone through an extensive series of performance tests during the manufacturing process. The MC275 is supplied with the actual Tubes that were used to test and confirm the performance of this amplifier. To protect the Vacuum Tubes from possible shipping damage, they are packed in four layers of foam and placed into the Tube Cover. It is secured to the MC275 Chassis.

Note: Gloves or a soft cloth will prevent "fingerprinting" of the Tubes during their installation.

1. Orient the MC275 so the Front Panel is facing you.
2. Remove the Tube Cover from the MC275 Chassis by lifting up on both sides. Refer to figure 1.
3. Orient the Tube Cover with the top side down so the foam containing the Tubes is accessible. Refer to figure 2.
4. Remove the first layer of foam to expose the Tubes. Refer to figure 3.
5. Carefully remove the Tubes from the remaining pieces of foam and temporarily place them in a safe location.
6. Remove the remaining foam from the Tube Cover and retain all four pieces for possible future use.

The MC275 Chassis has nomenclature screened on it to specify both the circuit location and Tube Type for each channel. Refer to figure 4.

Note: It is extremely important to insert the Tubes in the correct location.

Power Output Tubes:

1. Orient the Chassis so the Front Panel of the Amplifier is facing you.
2. Locate a KT88 or 6550 Power Output Tube.
3. On the top left side of the amplifier, locate the Tube Socket that has the nomenclature V8 KT88/6550 next to it on the chassis.
4. Orient the Tube so the key on the base of the Tube is aligned with the corresponding key on the Tube Socket.
5. Carefully insert the Tube into the socket until the base of the Tube is fully seated in the Tube Socket.
6. Repeat the above the steps for the remaining 4 Power Output Tubes.

There are two different types of Small Signal Tubes (12AX7A and 12AT7) used in each channel. Tube type can be found on the outside of the Tube. The MC275 will not function if they are inserted into the wrong socket.

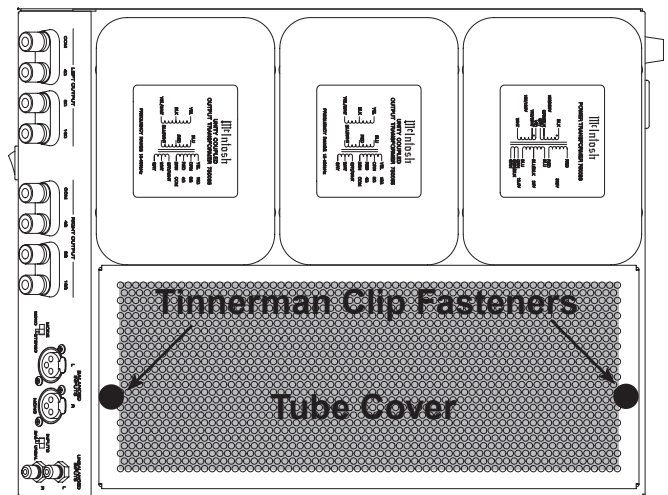

Figure 1

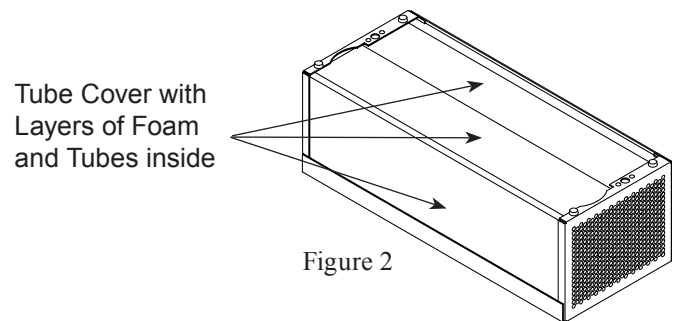

Figure 2

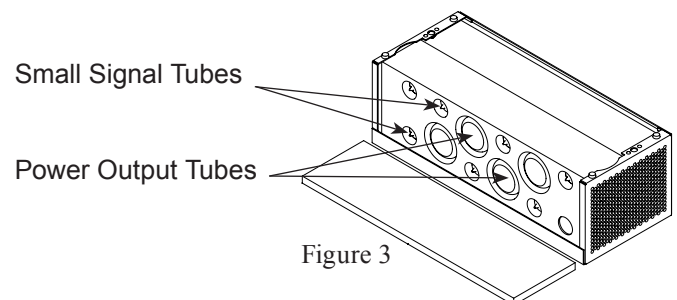
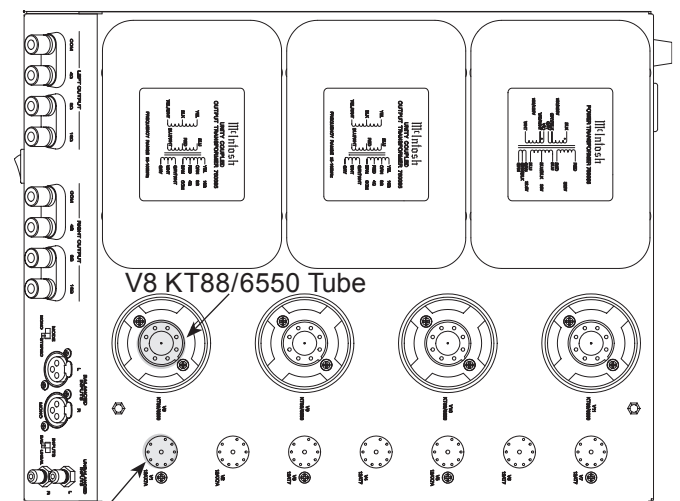

Figure 3



V1 12AX7A Tube

Figure 4

Small Signal Tubes:

1. Locate a 12AX7A Tube.
2. On the top left side of the amplifier, locate the Tube Socket that has the nomenclature V1 12AX7A next to it on the chassis. Refer to figure 4 and 5.
3. Orient the Tube so the area where no pins are located on the base of the Tube is aligned with the corresponding area on the Tube Socket.
4. Carefully insert the Tube into the socket until the base of the Tube is fully seated in the Tube Socket.
5. Repeat the above steps for the remaining two 12AX7A Tubes at locations V2 and V5.
6. Locate a 12AT7 Tube.
7. On the top center of the amplifier, locate the Tube Socket that has the nomenclature V3 12AT7A next to it on the chassis.
8. Insert the Tube, following the same procedure as in steps 3 and 4.
9. Repeat steps 6-9 for the remaining three 12AT7 Tubes at locations V4, V6 and V7.

Caution: To prevent electrical shock make sure the MC275 Tube Cover is installed before connecting the AC Power Cord.

Before operating the MC275, locate the previously removed Tube Cover and perform the following steps:

Installing the Tube Cover:

1. The Tube Cover has a wide opening along one side of its longer dimension. Orient this wide opening so it is facing towards the three large transformers.
2. Carefully place the Tube Cover onto the MC275 while at the same time aligning the two chassis mounted ball studs with the Tinnerman Clips in the cover. Refer to figure 6.

Location and Ventilation

The MC275 can be placed upright on a table or shelf, standing on its four feet. It also can be installed in a piece of furniture of your choice. Do not install the MC275 directly above a heat generating component. Adequate ventilation extends the trouble free life of the MC275. The suggested minimum space for operating the MC275 is 22 inches (55.88cm) in width, 18 inches (45.72cm) depth, and 21 inches (53.34cm) in height. Always allow air to flow through the ventilation holes on the bottom of the amplifier and a means for the warm air to escape at the top. If the MC275 is installed in a cabinet, a quiet running ventilation fan can be a definite asset in maintaining the coolest possible operating temperature. Refer to figure 7.

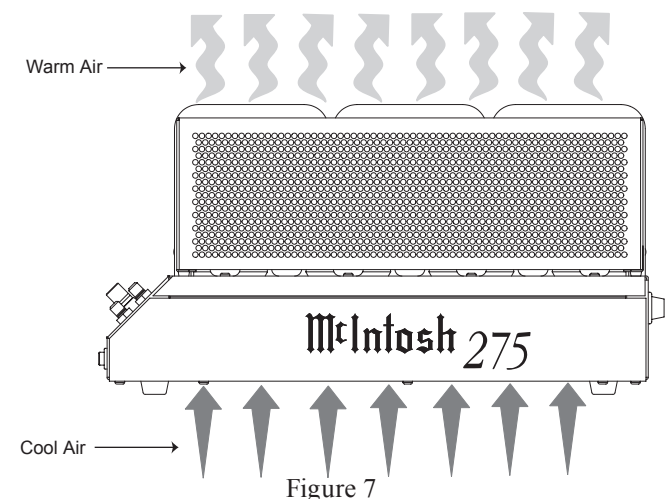
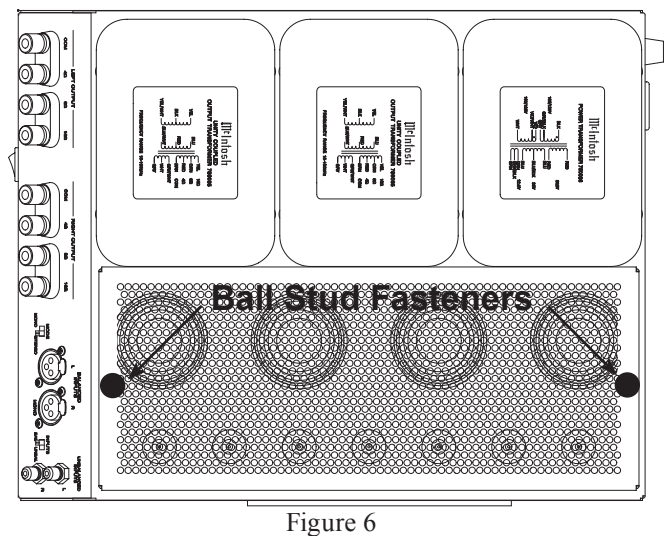
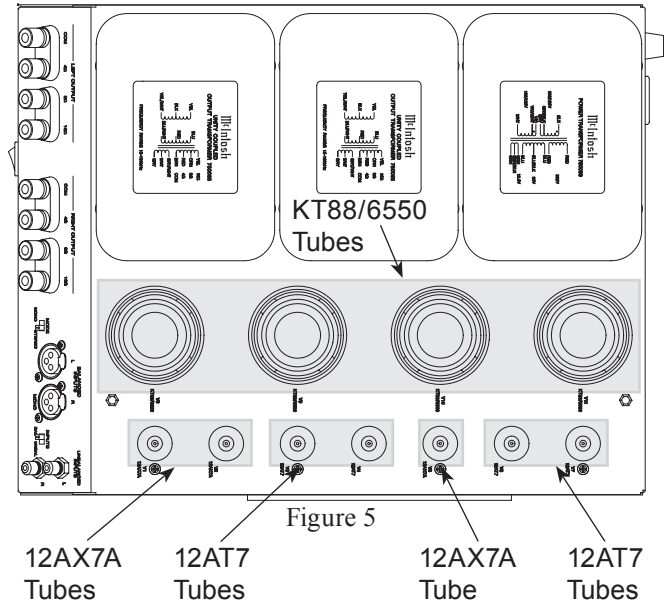



LEFT OUTPUT
Connections for
loudspeakers

RIGHT OUTPUT
Connections for
loudspeakers

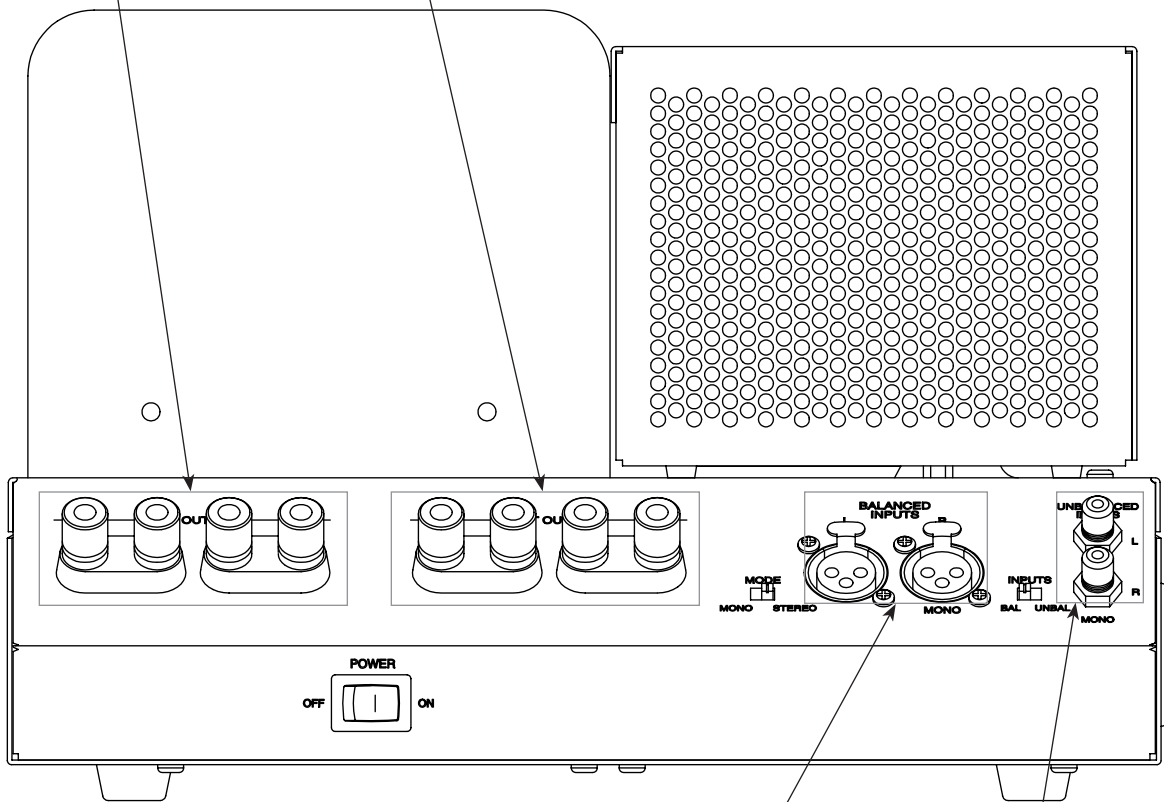

BALANCED INPUTS
for audio cables from a
preamplifier or control
center audio outputs

UNBALANCED INPUTS
for audio cables from a
preamplifier or control
center audio outputs

Right Side Panel Connection and Fuse Holder

Connect the MC275 power cord to a live AC outlet. Refer to information on the back panel to determine the correct voltage

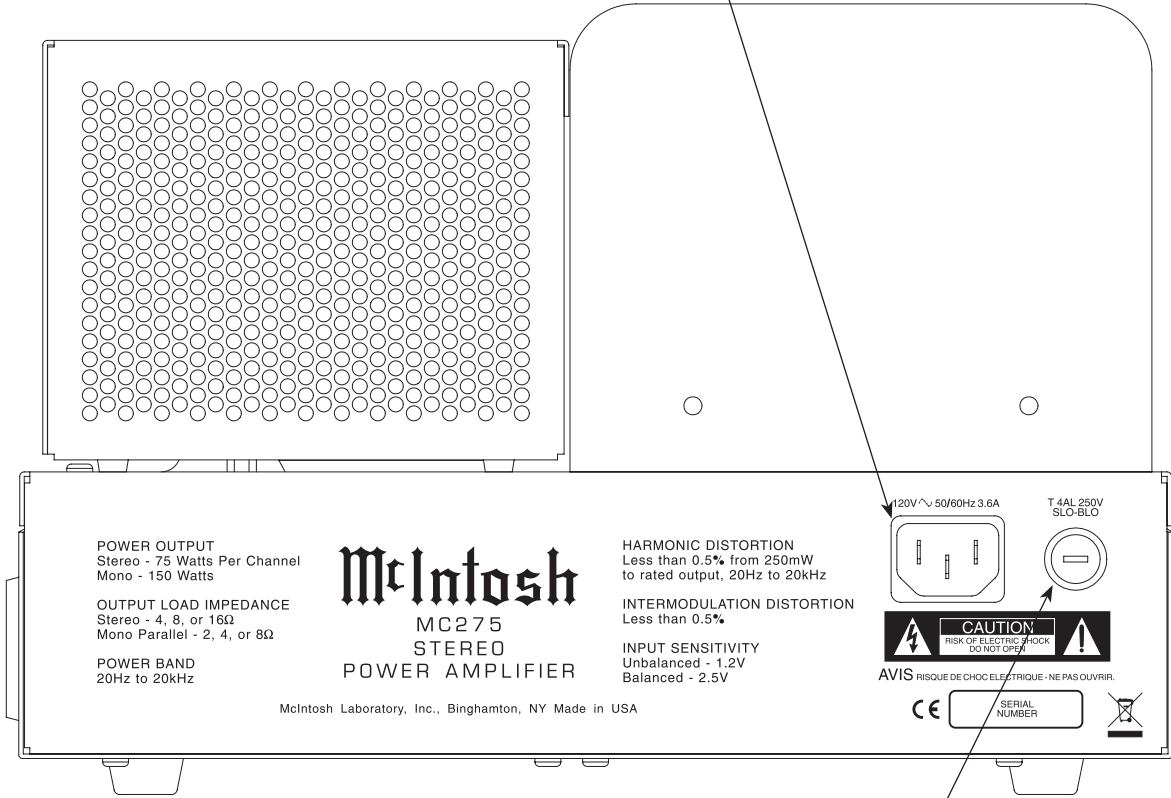

Main Fuse holder, refer to information on the back panel of your MC275 to determine the correct fuse size and rating

How to Connect for Stereo

Caution: The supplied AC Power Cord should not be connected to the Rear Panel of the MC275 Amplifier until after the Loudspeaker Connections have been made.

When connecting Loudspeakers to the MC275 it is very important to use cables of adequate size, so there is little to no power loss in the cables. The size is specified in Gauge Numbers or AWG (American Wire Gauge). The smaller the Gauge number, the larger the wire size:

If your loudspeaker cables are 50 feet (38.1m) or less, use at least 14 Gauge.

If your loudspeaker cables are 100 feet (76.2m) or less, use at least 12 Gauge.

1. Prepare the Loudspeaker Hookup Cables that attach to the Amplifier by choosing one of the methods below:

Bare wire cable ends:

Carefully remove sufficient insulation from the cable ends, refer to figures 1, 2 & 3. If the cable is stranded, carefully twist the strands together as tightly as possible.

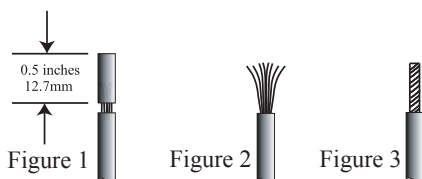

Note: If desired, the twisted ends can be tinned with solder to keep the strands together, or attach spade lug and/or banana connector.

McIntosh Loudspeaker

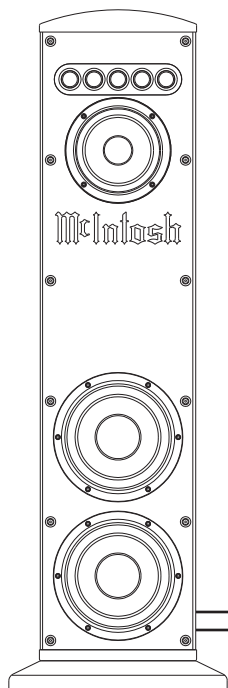

McIntosh MC275 (Partial View)

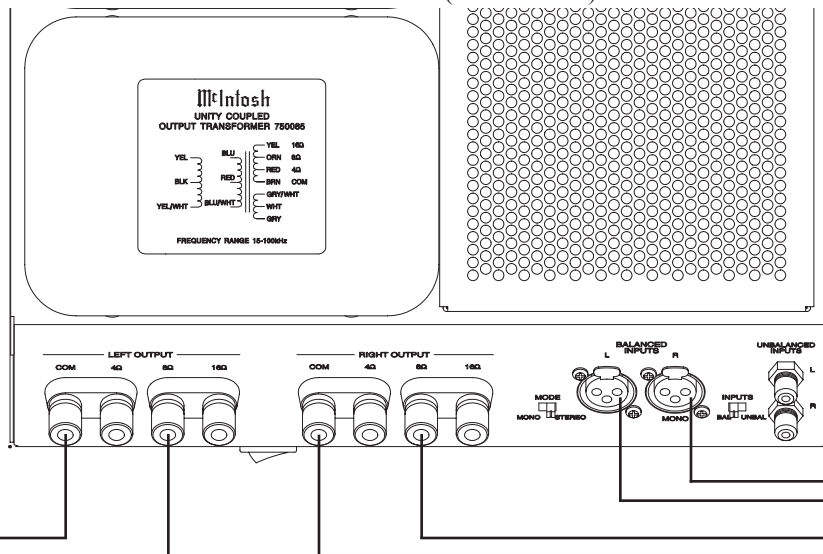

McIntosh Loudspeaker

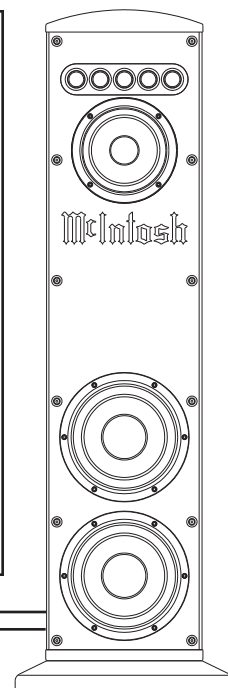

Spade lug or prepared wire connection:

Insert the spade lug connector or prepared section of the cable end into the terminal side access hole, and tighten the terminal cap until the cable is firmly

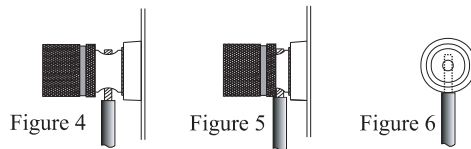

clamped into the terminal so the wires cannot slip out. Refer to figures 4, 5 & 6.

Banana plug connection:

Insert the banana plug into the hole at the top of the terminal. Refer to figure 7.

Note: Banana Plugs are for use in the United States and Canada only.

2. Connect the loudspeaker hookup cables to the output terminals that match the impedance of your loudspeakers, being careful to observe the correct polarities.
3. Connect the MC275 Power Cord to a live AC outlet.

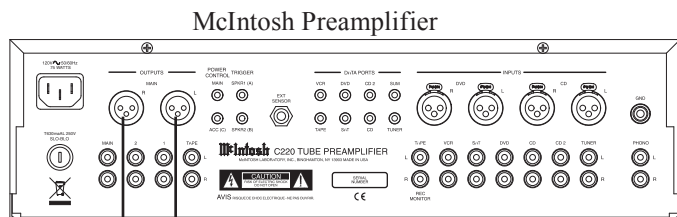
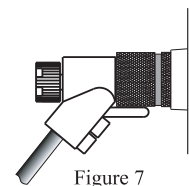

How to Connect for Mono Parallel

Caution: The supplied AC Power Cord should not be connected to the Rear Panel of the MC275 Amplifier until after the Loudspeaker Connections have been made.

When connecting Loudspeakers to the MC275 it is very important to use cables of adequate size, so there is little to no power loss in the cables. The size is specified in Gauge Numbers or AWG (American Wire Gauge). The smaller the Gauge number, the larger the wire size:

If your loudspeaker cables are 50 feet (38.1m) or less, use at least 14 Gauge.

If your loudspeaker cables are 100 feet (76.2m) or less, use at least 12 Gauge.

1. Prepare the Loudspeaker Hookup Cable and Jumper Wires for connection to the Power Amplifier Output Terminals; two 5-1/4 inch (13.34 cm) Jumper Wires and one Loudspeaker Hookup Cable cut to the desired length. Prepare the cable and wires by choosing one of the methods below:

Bare wire cable ends:

Carefully remove sufficient insulation from the cable ends, refer to figures 1, 2 & 3. If the cable is stranded, carefully twist the strands together as tightly as possible.

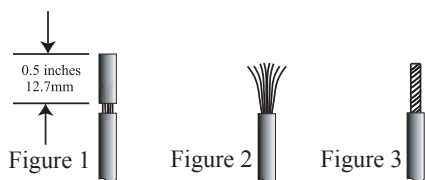

Note: If desired, the twisted ends can be tinned with solder to keep the strands together, or attach spade lug and/or banana connector.

Spade lug or prepared wire connection:

Insert the spade lug connector or prepared section of the cable end

McIntosh Loudspeaker

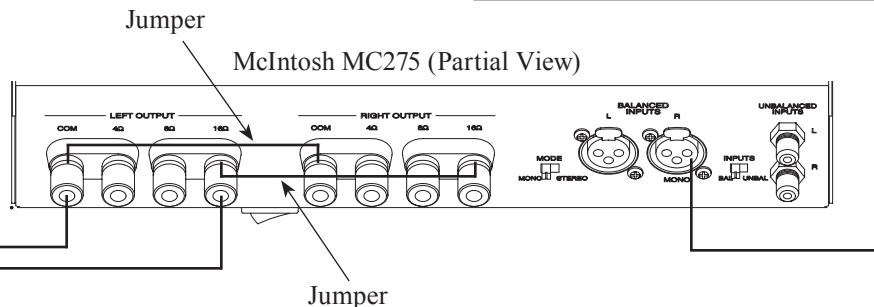
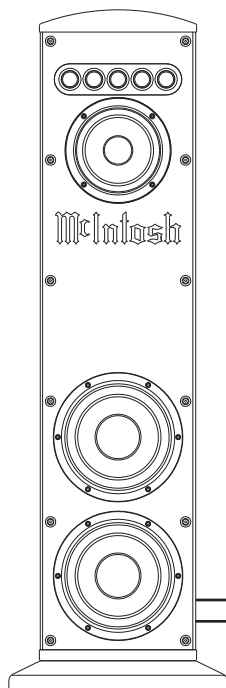

into the terminal side access hole, and tighten the terminal cap until

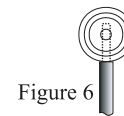
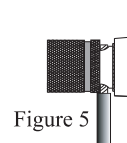
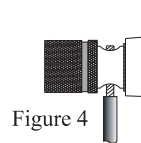

the cable is firmly clamped into the terminal so the wires cannot slip out. Refer to figures 4, 5 & 6.

Banana plug connection:

Insert the banana plug into the hole at the top of the terminal. Refer to figure 7.

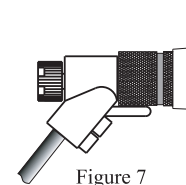

Note: Banana Plugs are for use in the United States and Canada only.

2. Connect the loudspeaker hookup cables to the output terminals that match the impedance of your loudspeakers, being careful to observe the correct polarities. Refer to the Mono (Parallel) Hookup Connections Chart below.
3. Connect the MC275 Power Cord to a live AC outlet.

Mono (Parallel) Hookup Connections		
Loudspeaker Impedance	Loudspeaker Negative (-) Connection	Loudspeaker Positive (+) Connection
2Ω (Ohm)	Left and Right Output COMMon Connection	Left and Right Output 4Ω Connection
4Ω (Ohm)	Left and Right Output COMMon Connection	Left and Right Output 8Ω Connection
8Ω (Ohm)	Left and Right Output COMMon Connection	Left and Right Output 16Ω Connection

McIntosh Preamplifier

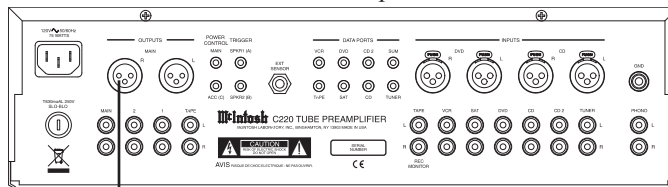

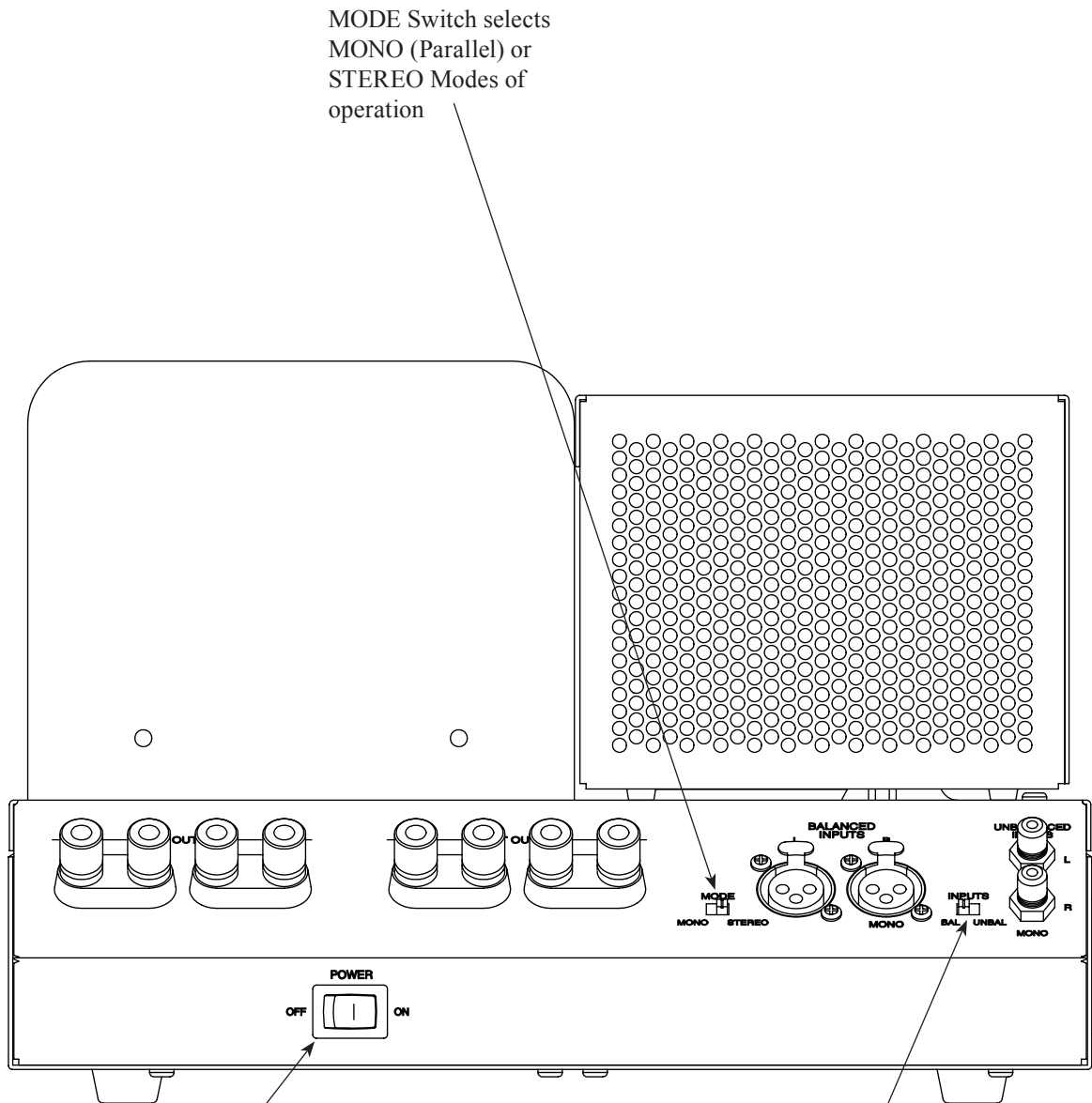

MODE Switch selects MONO (Parallel) or STEREO Modes of operation

Power Switch turns all AC power On or Off

INPUTS Switch selects between the BALANCED or UNBALANCED Inputs

How to Operate the MC275

Power On and Off

Press the POWER switch to the ON position and sound will be heard from the Loudspeakers when the tubes have reached their operating temperature.

The amount of time it takes is dependent upon the temperature of the Tubes. Press the POWER Switch to the Off position to stop amplifying the audio signal. Refer to figure 8.

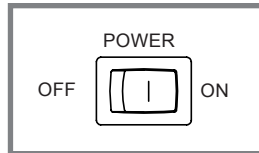

Figure 8

Note: If the MC275 is connected to a McIntosh Preamplifier, Control Center or A/V Center, the addition of a McIntosh Power Controller such as a PC4 will allow the MC275 to switch On and Off automatically.

Mode Switch

The MODE Switch, which is located on the Left Side Panel of the MC275, allows selection of either Stereo or Mono (Parallel) Modes of Operation. Refer to figure 9 and pages 10 and 11 for connection information.

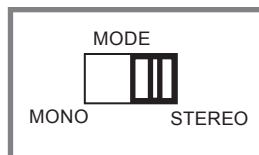

Figure 9

Input Switch

When BALANCED Input Connections are used, place the MC275 INPUT Switch to the BALANCED position. If UNBALANCED connections are used, place the INPUT Switch to the UNBALANCED position. Refer to figure 10.

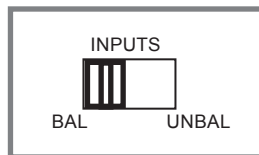

Figure 10



Specifications

Power Output Stereo

Minimum sine wave continuous average power output per channel, both channels operating is:
75 watts into 4, 8 or 16 ohm load

Power Output Mono (Parallel)

Minimum sine wave continuous average power output is:
150 watts into 2 ohm, 4 ohm or 8 ohm load

Output Load Impedance

4, 8, or 16 ohm (Stereo Mode)
2, 4, or 8 ohm (Mono Mode)

Rated Power Band

20Hz to 20,000Hz

Total Harmonic Distortion

Maximum Total Harmonic Distortion at any power level from 250 milliwatts to rated power output is 0.5%

Intermodulation Distortion

Maximum Intermodulation Distortion if instantaneous peak output per channel does not exceed twice the rated output, for any combination of frequencies from 20Hz to 20,000Hz, with both channels operating is 0.5%

A-Weighted Signal To Noise Ratio

100dB

Frequency Response

+0, -0.5dB from 20Hz to 20,000Hz
+0, -3dB from 10Hz to 70,000Hz

Sensitivity

1.2 Volt unbalanced inputs
2.5 Volt balanced inputs

Input Impedance

90,000 ohms unbalanced inputs
180,000 ohms balanced inputs

Wide Band Damping Factor

Greater than 14

Tube Compliment

3 - 12AX7A Inputs and Phase Inverters
4 - 12AT7 Voltage Amplifier and Drivers
4 - KT88/6550 Power Output

Power Requirements

100 Volts, 50/60Hz at 3.6 amps
110 Volts, 50/60Hz at 3.6 amps
120 Volts, 50/60Hz at 3.6 amps
220 Volts, 50/60Hz at 1.8 amps
230 Volts, 50/60Hz at 1.8 amps
240 Volts, 50/60Hz at 1.8 amps

Note: Refer to the right side panel of the MC275 for the correct voltage.

Overall Dimensions

Width is 16-1/2 inches (41.91cm)
Height is 8-1/4 inches (20.96cm) including feet
Depth is 12 inches (30.48cm)

Weight

67 pounds (30.5kg) net, 75 pounds (34.1kg) in shipping carton

Packing Instructions

In the event it is necessary to repack the equipment for shipment, the equipment must be packed exactly as described and shown below.

The MC275 Vacuum Tubes must be removed from the Amplifier Tube Sockets and placed into the openings of the four layer foam packing material. The foam with the tubes located inside are placed into the Amplifier Tube Cover and secured to the Chassis. Failure to do this will result in damage to the Vacuum Tubes and possibly the MC275.

It is very important that the four plastic feet are attached to the bottom of the equipment. This will ensure the proper equipment location on the bottom pad. Failure to do this will result in shipping damage.

Use the original shipping carton and interior parts only if they are all in good serviceable condition. If a shipping carton or any of the interior part(s) are needed, please call or write Customer Service Department of McIntosh Laboratory. Please see the Part List for the correct part numbers.

Quantity	Part Number	Description
1	034005	Shipping carton outside
2	033718	Foam Pad (side)
2	034266	Foam pack tube (ends)
2	034265	Foam pack tube (inside with tube cutouts)
1	034006	Shipping carton inside
1	033707	Top pad
1	033712	Foam pad (tube cover)
1	033704	Bottom pad
1	033705	Front pad
1	033706	Rear pad
1	033711	Side pads
4	017862	Plastic foot

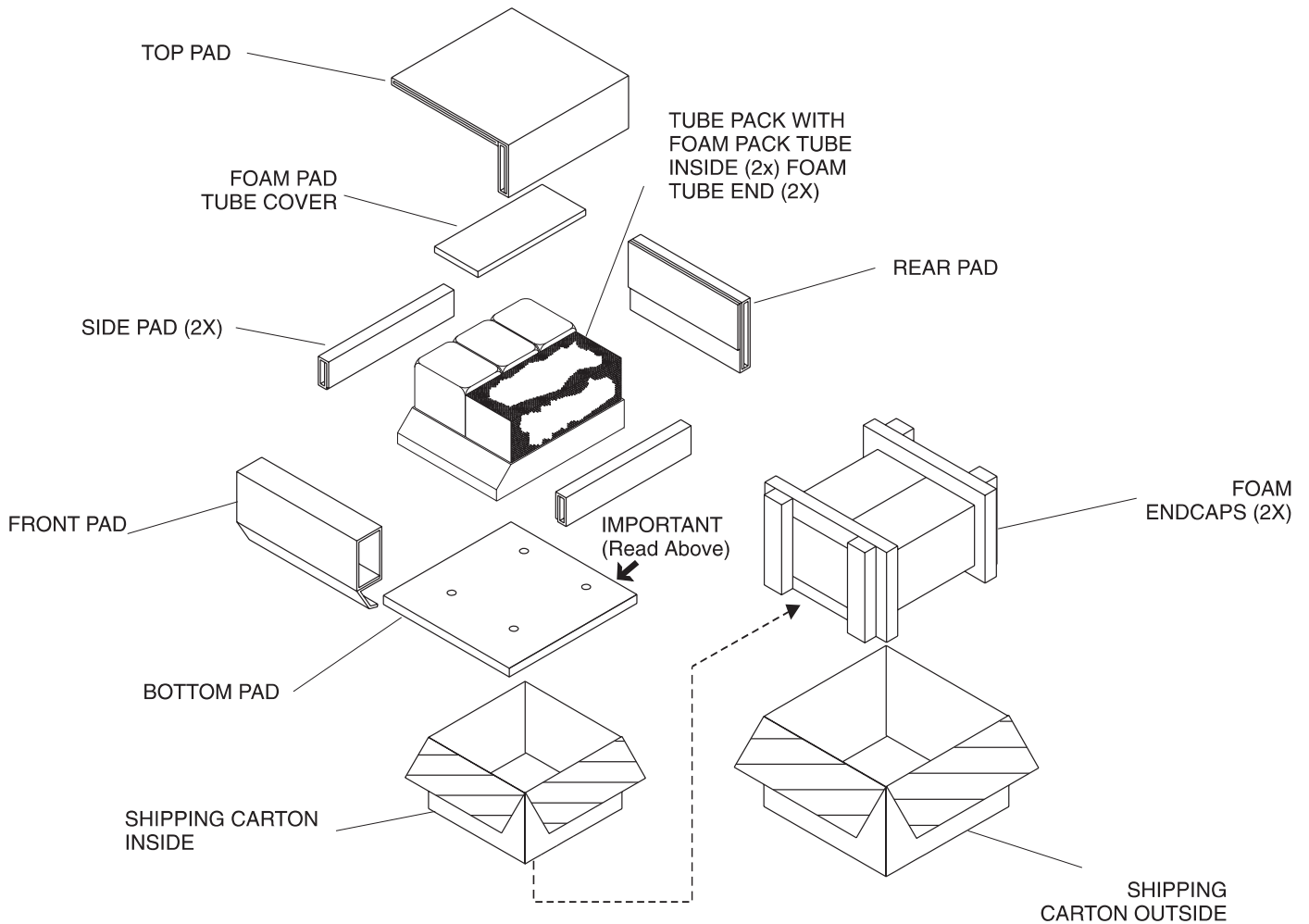



McIntosh Laboratory, Inc.
2 Chambers Street
Binghamton, NY 13903

The continuous improvement of its products is the policy of McIntosh Laboratory Incorporated who reserve the right to improve design without notice. Printed in the U.S.A.

McIntosh Part No. 04099600