

MC58 Eight Channel Power Amplifier



MC58

The lightning flash with arrowhead, within an equilateral triangle, is intended to alert the user to the presence of uninsulated "dangerous voltage" within the product's enclosure that may be of sufficient magnitude to constitute a risk of electric shock to persons.



AVIS RISQUE DE CHOC ELECTRIQUE - NE PAS OUVRIR.

The exclamation point within an equilateral triangle is intended to alert the user to the presence of important operating and maintenance (servicing) instructions in the literature accompanying the appliance.

WARNING - TO REDUCE RISK OF FIRE OR ELECTRICAL SHOCK, DO NOT EXPOSE THIS EQUIPMENT TO RAIN OR MOISTURE.

NO USER-SERVICEABLE PARTS INSIDE. REFER SERVICING TO QUALIFIED PERSONNEL.

To prevent the risk of electric shock, do not remove cover or back. No user serviceable parts inside.

IMPORTANT SAFETY INSTRUCTIONS!

PLEASE READ THEM BEFORE OPERATING THIS EQUIPMENT.

General:

1. Read these instructions.
2. Keep these instructions.
3. Heed all warnings.
4. Follow all instructions.
5. **Warning: To reduce risk of fire or electrical shock, do not expose this equipment to rain or moisture. This unit is capable of producing high sound pressure levels. Continued exposure to high sound pressure levels can cause permanent hearing impairment or loss. User caution is advised and ear protection is recommended when playing at high volumes.**
6. **Caution: to prevent electrical shock do not use this (polarized) plug with an extension cord, receptacle or other outlet unless the blades can be fully inserted to prevent blade exposure.**
Attention: pour prevenir les chocs electriques pas utiliser cette fiche polarisee avec un prolongateur, une prise de courant ou un autre sortie de courant, sauf si les lames peuvent etre inserees afond ans en laisser aucune partie a decouvert.
7. Unplug this equipment during lightning storms or when unused for long periods of time.
8. Only use attachments/accessories specified by the manufacturer.

Installation:

9. The equipment shall be installed near the AC Socket Outlet and the disconnect device shall be easily accessible.
10. Do not block any ventilation openings. Install in accordance with the manufacturer's instructions.
11. Do not install near any heat sources such as radiators, heat registers, stoves, or other equipment (including amplifiers) that produce heat.
12. Do not use this equipment near water.
13. Do not expose this equipment to dripping or splashing and ensure that no objects filled with liquids, such as vases, are placed on the equipment.
14. Use only with the cart, stand, tripod, bracket, or table specified by the manufacturer, or sold with the equipment. When a cart is used, use caution when moving the cart/equipment combination to avoid injury from tip-over.



Connection:

15. Connect this equipment only to the type of AC power source as marked on the unit.
16. Protect the power cord from being walked on or pinched particularly at plugs, convenience receptacles, and the point where they exit from the equipment.
17. Do not defeat the safety purpose of the polarized or grounding-type plug.

A polarized plug has two blades with one wider than the other. A grounding type plug has two blades and a third grounding prong. The wide blade or the third prong are provided for your safety. If the provided plug does not fit into your outlet, consult an electrician for replacement of the obsolete outlet.

18. Do not overload wall outlets, extension cords or integral convenience receptacles as this can result in a risk of fire or electric shock.
19. To completely disconnect this equipment from the AC Mains, disconnect the power supply cord plug from the AC receptacle.

Care of Equipment:

20. Clean only with a dry cloth.
21. Do not permit objects or liquids of any kind to be pushed, spilled and/or fall into the equipment through enclosure openings.
22. Unplug the power cord from the AC power outlet when left unused for a long period of time.

Repair of Equipment:

23. Refer all servicing to qualified service personnel. Servicing is required when the equipment has been damaged in any way, such as power-supply cord or plug is damaged, liquid has been spilled or objects have fallen into the equipment, the equipment has been exposed to rain or moisture, does not operate normally, or has been dropped.
24. Do not attempt to service beyond that described in the operating instructions. All other service should be referred to qualified service personnel.
25. When replacement parts are required, be sure the service technician has used replacement parts specified by McIntosh or have the same characteristics as the original part. Unauthorized substitutions may result in fire, electric shock, or other hazards.
26. Upon completion of any service or repairs to this product, ask the service technician to perform safety checks to determine that the product is in proper operating condition.

Thank You

Your decision to own this McIntosh MC58 Eight Channel Power Amplifier ranks you at the very top among discriminating music listeners. You now have "The Best." The McIntosh dedication to "Quality," is assurance that you will receive many years of musical enjoyment from this unit.

Please take a short time to read the information in this manual. We want you to be as familiar as possible with all the features and functions of your new McIntosh.

Please Take A Moment

The serial number, purchase date and McIntosh dealer name are important to you for possible insurance claim or future service. The spaces below have been provided for you to record that information:

Serial Number: _____

Purchase Date: _____

Dealer Name: _____

Technical Assistance

If at any time you have questions about your McIntosh product, contact your McIntosh dealer who is familiar with your McIntosh equipment and any other brands that may be part of your system. If you or your dealer wish additional help concerning a suspected problem, you can receive technical assistance for all McIntosh products at:

McIntosh Laboratory, Inc.
2 Chambers Street
Binghamton, New York 13903
Phone: 607-723-1545
Fax: 607-723-3636

Customer Service

If it is determined that your McIntosh product is in need of repair, you can return it to your dealer. You can also return it to the McIntosh Laboratory Service Repair department. For assistance on factory repair return procedure, contact the McIntosh Repair Department at:

McIntosh Laboratory, Inc.
2 Chambers Street
Binghamton, New York 13903
Phone: 607-723-3515
Fax: 607-723-1917

Table of Contents

Thank You	2
Safety Instructions	2
Thank You and Please Take a Moment	3
Technical Assistance and Customer Service	3
Table of Contents and General Notes	4
Connector Information	4
Introduction	5
Performance Features	5
Dimensions	6
Installation	7
Rear Panel Controls, Connections and Switch	8
How to Connect with a CR16	9
How to Connect two MC58s in Bridge Mode	10
How to Connect in a Home Theater System	11
Front Panel Displays and Controls	12
How to Operate	13
Specifications	14
Packing Instruction	15

General Notes

1. Connecting Cables and Connectors are available from the McIntosh Parts Department:
Data and Power Control Cable Part No. 170-202
 Six foot, shielded 2 conductor, with 1/8 inch stereo mini phone plugs on each end.
Control Center to Multichannel Power Amplifier Cable Part No. 170-631
 Six foot, DB25, shielded, straight through, 25 conductor male-to-female cable.
Multizone Control System to Multichannel Power Amplifier Cable Part No. 170-147
 Six foot, 7Pin DIN, shielded, male-to-male cable.
2. For additional connection information, refer to the owner's manual(s) for any component(s) connected to the MC58 Amplifier.
3. There is a built-in turn on delay which will mute the speaker outputs for approximately two seconds when the amplifier is turned on.
4. It is very important that loudspeaker cables of adequate size be used in your music system, to ensure that there will be no power loss or heating. Cable size is specified in Gauge numbers or AWG, (American Wire Gauge). The smaller the Gauge number, the larger the wire size:
 If your loudspeaker cables are 25 feet (7.62m) or less, use at least 18 Gauge (AWG) wire size or larger.
 If your loudspeaker cables are 50 feet (38.1m) or less, use at least 16 Gauge (AWG) wire size or larger.
 If your loudspeaker cables are 100 feet (76.2m) or less, use at least 14 Gauge (AWG) wire size or larger.

Connector Information

Multi-Room Din Connector Pin Layout

1. Zone 3-Pwr. Ctrl.
2. Zone 1-Pwr. Ctrl.
3. Pwr. Ctrl. (Main)
4. Zone 2-Pwr. Ctrl.
5. Video Power
6. Zone 4-Pwr. Ctrl.
7. Gnd.

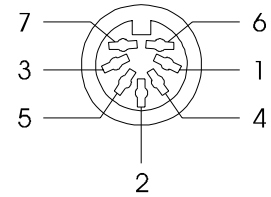

8 Channel In DB25 Connector Pin Layout

- | | |
|-----------------------|----------------------------|
| 1. Zone 2-Left | 14. Zone 2-Left Gnd. |
| 2. Zone 1-Left | 15. Zone 1-Left Gnd. |
| 3. Zone 2-Right | 16. Zone 2-Right Gnd. |
| 4. Zone 3-Left | 17. Zone 3-Left Gnd. |
| 5. Zone 1-Right | 18. Zone 1-Right Gnd. |
| 6. Zone 3-Right | 19. Zone 3-Right Gnd. |
| 7. Zone 4-Left | 20. Zone 4-Left Gnd. |
| 8. Zone 4-Right | 21. Zone 4-Right Gnd. |
| 9. N/C | 22. N/C |
| 10. N/C | 23. Zone 3-Pwr. Ctrl. |
| 11. Zone 1-Pwr. Ctrl. | 24. Zone 4-Pwr. Ctrl. |
| 12. Zone 2-Pwr. Ctrl. | 25. Pwr. Ctrl. Gnd. (Main) |
| 13. Pwr. Ctrl. (Main) | |

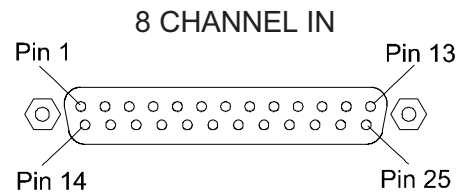

Introduction

Eight 50 watt McIntosh amplifier channels in one convenient package make the MC58 an ideal amplifier for a multizone system. The MC58 can be configured in different Operating Modes to fit a wide range of uses where a multichannel amplifier is required. For example, it has the ability to bridge a pair of channels for 100 watts output.

Performance Features

● Power Output

The MC58 consists of eight separate power amplifier channels, each capable of 50 watts into 4 ohm speakers with less than 0.005% distortion. This is 400 watts of McIntosh power in a single package.

● Power Guard

All eight channels include the patented McIntosh Power Guard Circuit, that prevents the amplifier from being overdriven into clipping with its harsh distorted sound that can also damage your valuable loudspeakers.

● Sentry Monitor

McIntosh Sentry Monitor power output stage protection circuits are present on all eight channels to ensure the MC58 will have a long and trouble free operating life.

● Thermal Protection

Built-in thermal protection circuits guard against overheating which could shorten the normal long life expectancy of your McIntosh power amplifier.

● Direct Current Protection

Direct Current sensing circuits on each channel provide extra protection for your valuable loudspeakers.

● Convenient Single Cable Hookup

A rear panel connector provides for the convenience of using a single cable, (DB25 computer style) to receive all audio and power control signals from a McIntosh Multizone Control System.

● Individual Channel or Bridged Pair Configuration

Each pair of MC58 amplifier channels can be operated separately at 50 watts each, or bridged for 100 watts. The MC58 is ideal for any application requiring a multichannel power amplifier, such as a multizone system or home theater system.

● Front Panel

The classic McIntosh Illuminated glass front panel includes eight individual channel power guard indicators, four channel pair status indicators and a Power On/Off switch.

MC58 Dimensions

The following dimensions can assist in determining the best location for your MC58. There is additional information on the next page pertaining to installing the MC58 into cabinets.

Front View of the MC58



Rear View of the MC58

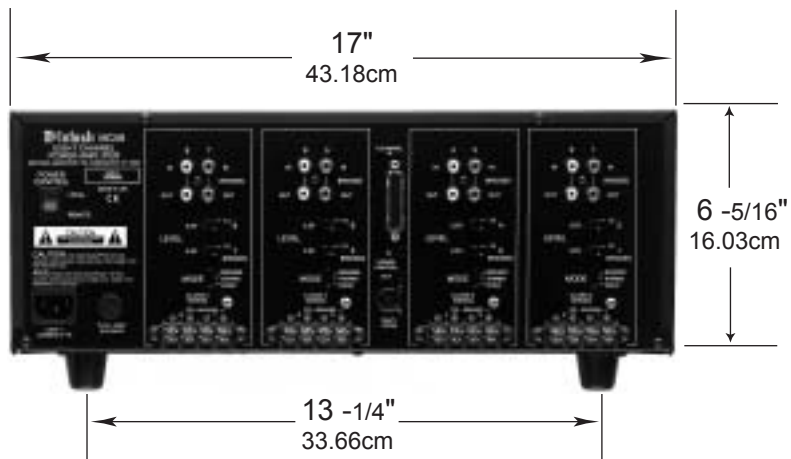

Side View of the MC58

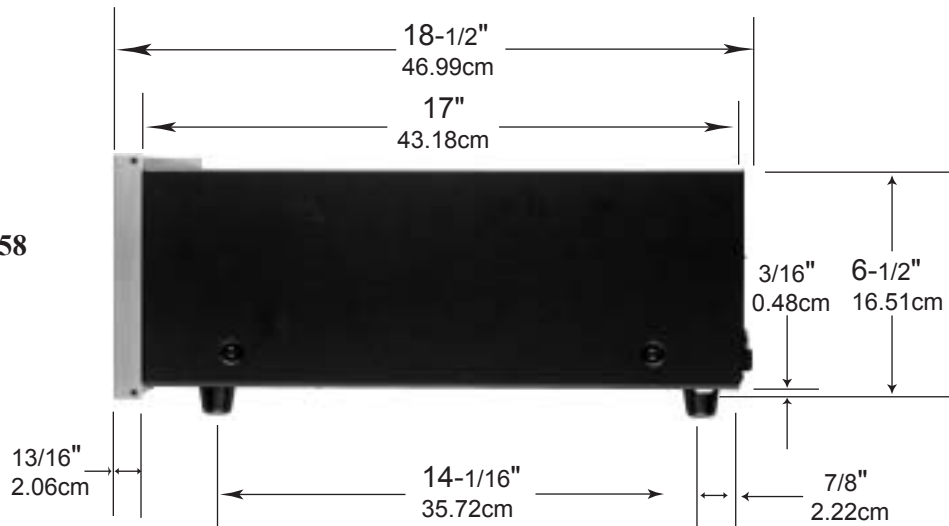

Installation

The MC58 can be placed upright on a table or shelf, standing on its four 1 inch high feet. The four feet may be removed from the bottom of the MC58 when it is custom installed as outlined below. The four feet together with the mounting screws should be retained for possible future use if the MC58 is removed from the custom installation and used free standing. It also can be custom installed in a piece of furniture or cabinet of your choice. The required panel cut-out, ventilation cut-out and unit dimensions are shown.

Always provide adequate ventilation for your MC58. Cool operation ensures the longest possible operating life for any electronic instrument. Do not install the MC58 directly above a heat generating component such as a high powered amplifier. If all the components are installed in a single cabinet, a quiet running ventilation fan can be a definite asset in maintaining all the system components at the coolest possible operating temperature.

A custom cabinet installation should provide the following minimum spacing dimensions for cool operation. Allow at

least 6 inches (15.24 cm) above the top, 2 inches (3.81cm) below the bottom and 1 inch (2.54 cm) on each side of the power amplifier, so that airflow is not obstructed. Allow 20 inches (50.8 cm) depth behind the front panel. Be sure to cut out a ventilation hole in the mounting shelf according to the dimensions in the drawing.

**MC58 Front Panel
Custom Cabinet Cutout**

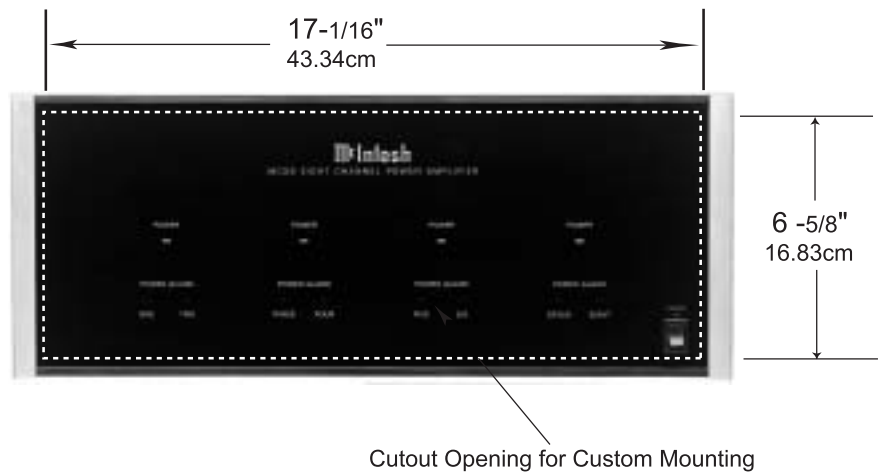

**MC58 Side View
in Custom Cabinet**

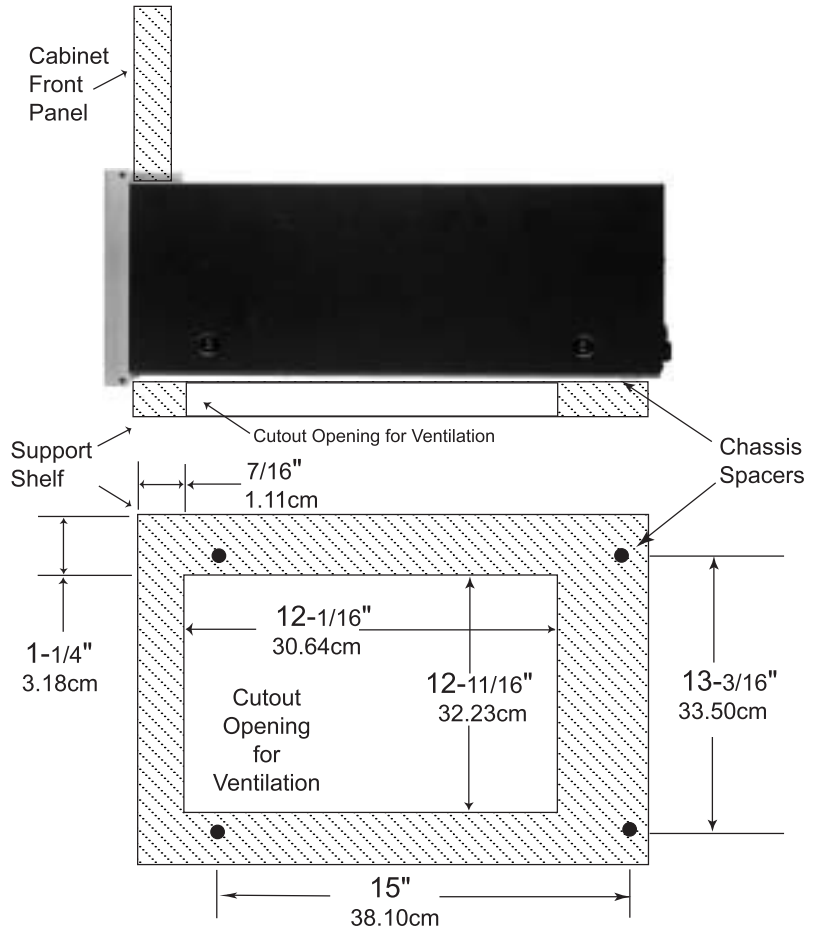

**MC58 Bottom View
in Custom Cabinet**

POWER CONTROL IN receives turn on/off signals from a McIntosh component and the POWER CONTROL OUT sends that turn on/off signal to the next McIntosh component

IN for discrete audio cables from a Multizone Control or Home Theater System and OUT sends the input signal to another component

Selects power turn-on mode

8 CHANNEL IN accepts a 25 conductor DB25 computer type cable that connects all audio and power control signals

Individual Input Level controls

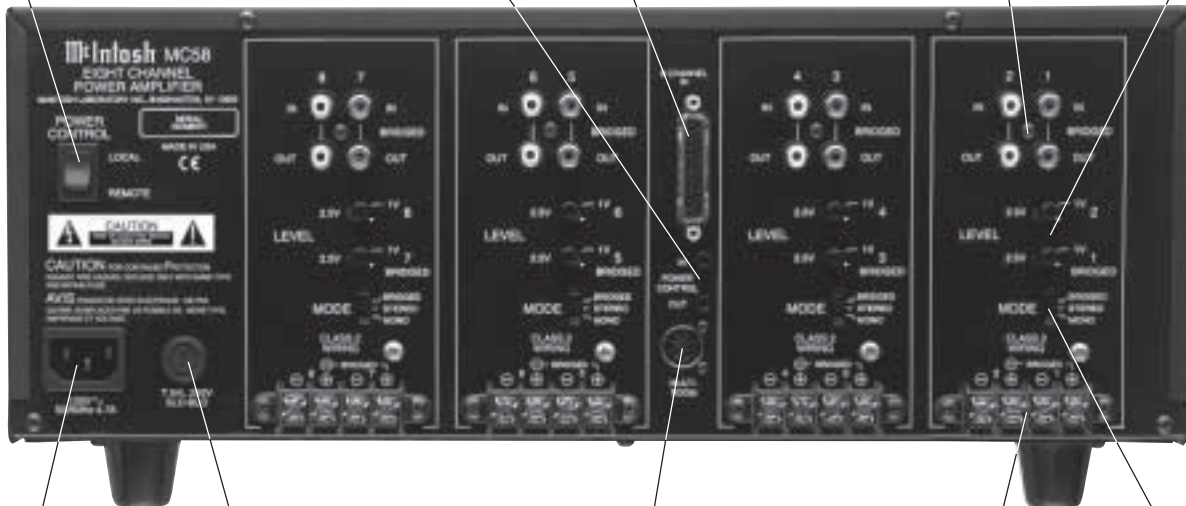

Connect the MC58 power cord to a live AC outlet. Refer to information on the back panel to determine the correct voltage

Receives zone turn-on control signals from a McIntosh Multizone system

Channel pair Mode switch

Main Fuse holder, refer to information on the back panel of your MC58 to determine the correct fuse size and rating

OUTPUT Connections for 8 or 4 ohm loudspeakers

How to Connect with a CR16

- 1. Connect the loudspeaker cables to the appropriate channel output connectors, being careful to observe the correct polarities.
- 2. Connect a single DB25 computer type cable from the Multichannel Output of a Multizone Control System to the MC58 8 CHANNEL INPUT connector for all eight audio channels and power control.

Note: Both audio and zone power control pass through this cable. Discrete zone audio cables may also be used, additionally connect a cable from the CR16 Din Multichannel Amp connector to the matching connector on the amplifier to provide Zone Power Control.

- 3. Connect the MC58 power cord to a live AC outlet.

McIntosh CR16 Multizone Control System

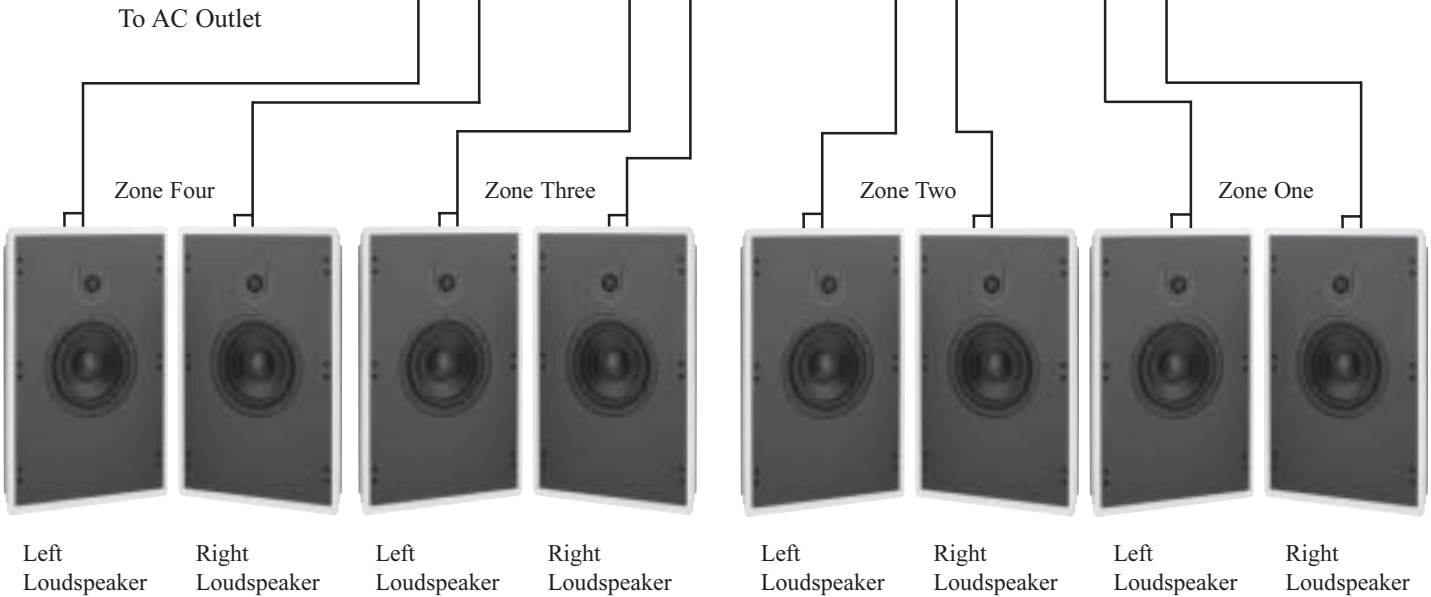
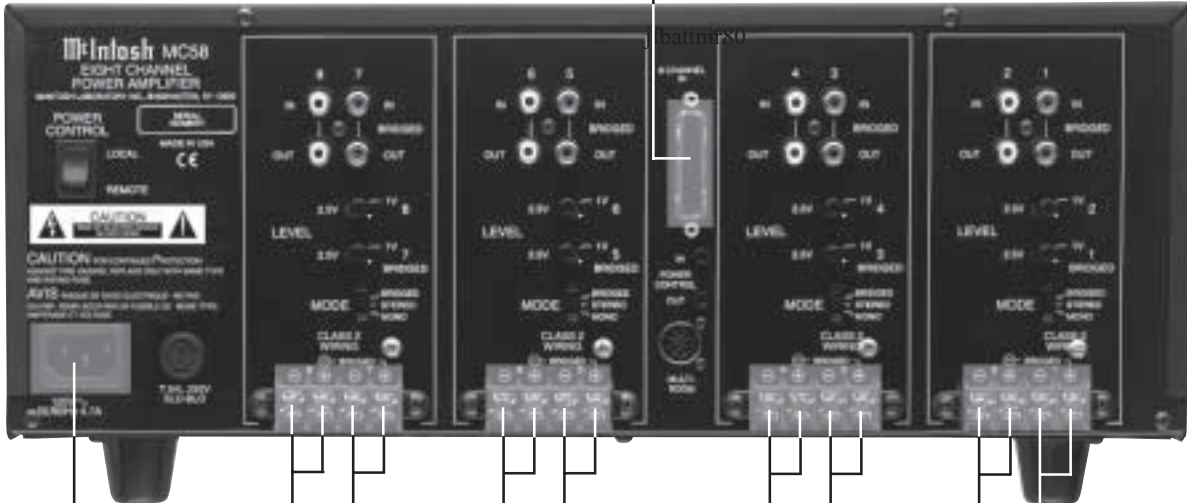
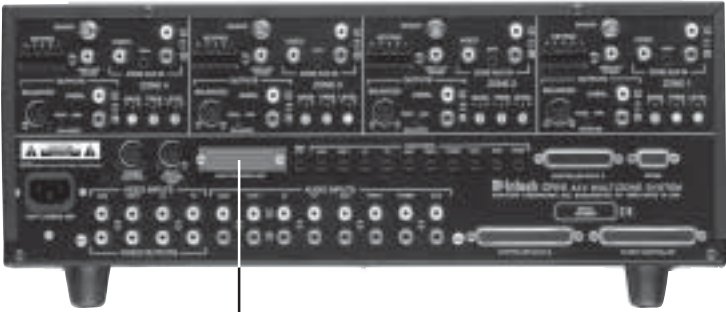

How to Connect two MC58s in Bridge Mode

The MC58 Eight Channel Power Amplifier has a Bridge Mode, which doubles the power output for each of the four Stereo Amplifier Pairs. Two MC58s, together with a CR16 provides higher power out for each of the four Zones.

Note: Only Zone One is illustrated below. Follow a similar procedure for Zones Two through Four on the MC58.

1. Connect the Loudspeaker Cables to the appropriate Bridged Channel Output Connections, being careful to observe the correct polarities.
2. Connect a 7 Pin DIN cable from the Power Control Output of a Multizone Control System to the MC58 MULTI-ROOM Connector (Left Channel Amplifier).
3. Connect a 7 Pin DIN cable from the Multichannel Output of a Multizone Control System to the MC58 MULTI-ROOM Connector (Right Channel Amplifier).
4. Connect an Audio Cable from the Zone 1 Left Channel Unbalanced Output of a Multizone Control System, to the MC58 IN 1 Connector (Left Channel Amplifier).

5. Connect an Audio Cable from the Zone 1 Right Channel Unbalanced Output of a Multizone Control System, to the MC58 IN 1 Connector (Right Channel Amplifier).
6. Connect the MC58 power cord to a live AC outlet.

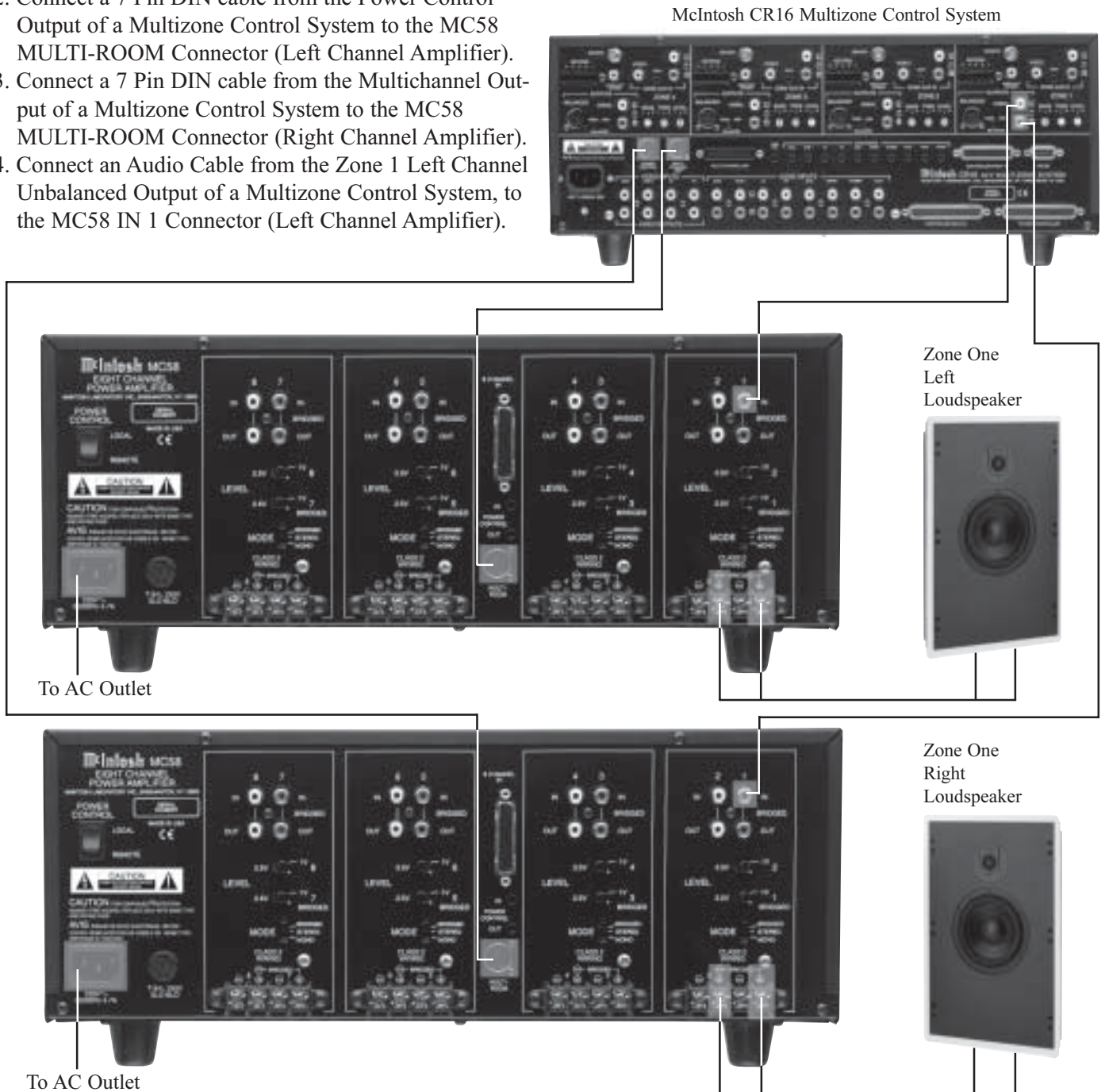

How to Connect in a Home Theater System

The MC58 Eight Channel Power Amplifier can be used in a Home Theater System with three of the six channels in Bridge Mode. This doubles the power output for the three front channels.

1. Connect the Loudspeaker Cables to the appropriate Bridged and Non-Bridged Channel Output Connections, being careful to observe the correct polarities.
2. Connect a power control cable from the Power Control Output of a Surround Decoder, to the MC58 POWER CONTROL IN Connector.
3. Connect Audio Cables from the Surround Decoder Outputs to the MC58 Inputs as follows:
 - a. Front Right Output to IN 1
 - b. Front Center Output to IN 3
 - c. Front Left Output to IN 5
 - d. Right Surround Output to IN 7
 - e. Left Surround Output to IN 8
4. Connect an Audio Cable from the Surround Decoder Outputs to the Powered Subwoofer Input.
5. Connect the MC58 power cord to a live AC outlet.

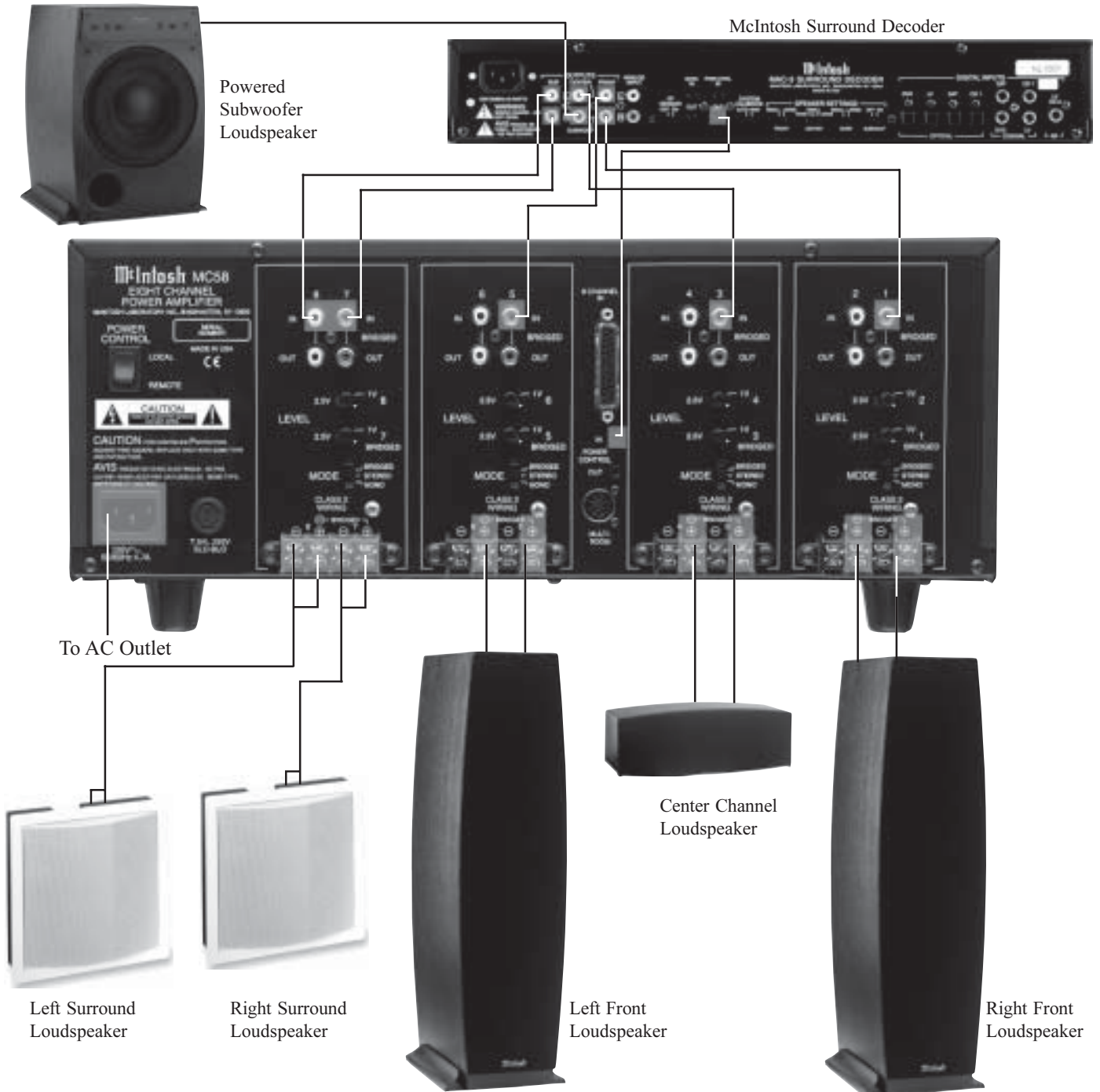

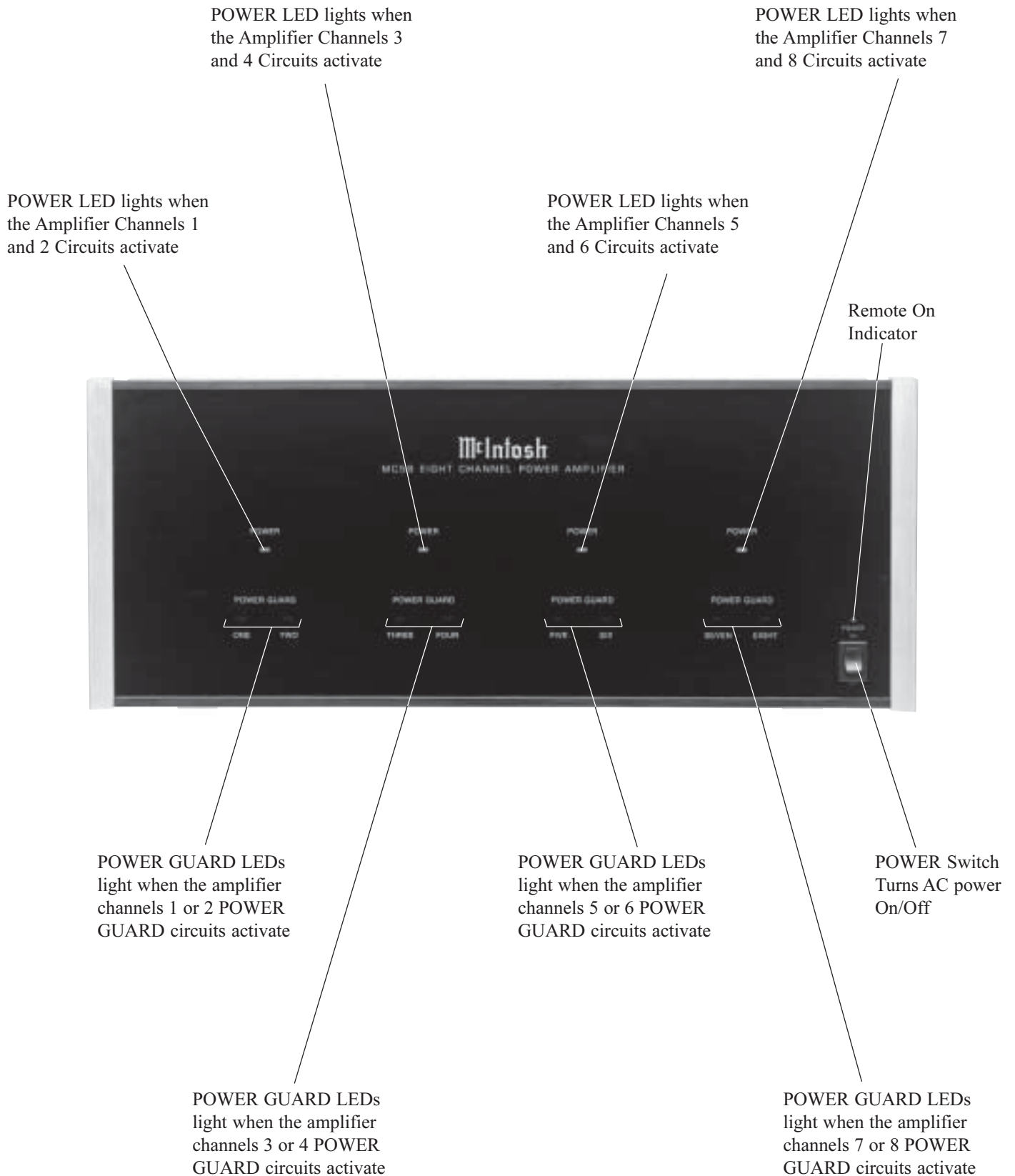

How to Operate the MC58

Power On

To have the MC58 turn on or off when a multizone system turns on or off, the front panel power switch must be left in the on position and the rear panel power control switch must be in the remote position. For non-remote operation, set the rear panel power control switch to local and use the front panel power switch to turn the MC58 on or off as desired. Refer to figure 1.

Note: There must be a power control connection between the MC58 and the McIntosh Multizone Control System or Control Center in order for the remote power turn on to function.



Figure 1

Input Level Controls

When using a McIntosh Multizone Control System or Control Center set all five level controls to the 2.5V position. If a preamplifier or control center has a 1V output rating, set the controls to the 1V position. If an increase or decrease in amplifier sensitivity is required for other applications, set the controls as desired. Refer to figure 2.



Figure 2

Mode Switch

The Mode switch allows a pair of MC58 channels to be used in three different operating configurations. Refer to figure 3.



Figure 3

- Stereo: Each channel of a stereo pair operates independently as left and right stereo 50 watt amplifiers.
- Bridged: A channel pair operates in bridged configuration for a single monaural 100 watt amplifier.
- Mono: Channel pair inputs are connected in parallel resulting in identical outputs for each channel.

How to Operate with a Bridged Channel

The versatile McIntosh MC58 can be used in three different Operating Modes. The four channel pairs can be used in Stereo Mode to supply 50 watts of power to four zones of a multizone system. Any of the four stereo pairs can be set to Bridged Mode to supply 100 watts of power when greater power is desired. The Mono Mode allows two channels to supply identical mono audio to two separate loudspeakers. A pair of MC58 channels in Bridged Mode will produce 100 watts output into an 8 ohm loudspeaker. Refer to figures 2, 3 and 4.



Figure 4

1. Set the Mode switch to the Bridged position.
2. Adjust the Bridged Level control to the 2.5V position if using a McIntosh Multizone System or Control Center.
3. Connect the cable from the signal source component to the Bridged In jack.
4. Connect loudspeaker cables to the terminals marked (-) and (+) Bridged.

Specifications

Power Output Per Channel

50 watts into 4 ohm load and 30 watts into 8 ohm load is the minimum sine wave continuous average power output per channel, all channels operating.

Power Output Bridged

100 watts into 8 ohm load is the minimum sine wave continuous average power output per channel, all channels operating.

Rated Power Band

20Hz to 20,000Hz

Total Harmonic Distortion

Maximum Total Harmonic Distortion at any power level from 250 milliwatts to rated power output is:

0.005% for 4 ohm loads

0.005% for 8 ohm loads

0.005% for Bridged Mode with 8 ohm loads

Dynamic Headroom

1.8dB

Frequency Response

+0, -0.25dB from 20Hz to 20,000Hz

+0, -3.0dB from 10Hz to 100,000Hz

Sensitivity

1 volt (2.5V at level control center detent position)

A-Weighted Signal To Noise Ratio

92dB (112dB below rated output)

Wideband Damping Factor

100 @ 4 ohms

200 @ 8 ohms

Intermodulation Distortion

Maximum Intermodulation Distortion if instantaneous peak output per channel does not exceed twice the rated output, for any combination of frequencies from 20Hz to 20,000Hz, with all channels operating is:

0.005% for 4 ohm loads

0.005% for 8 ohm loads

0.005% for Bridged Mode with 8 ohm loads

Input Impedance

20,000 ohms

Power Requirements

100 Volts, 50/60Hz at 5.4 amps

110 Volts, 50/60Hz at 4.9 amps

120 Volts, 50/60Hz at 4.7 amps

220 Volts, 50/60Hz at 3.1 amps

230 Volts, 50/60Hz at 3.1 amps

240 Volts, 50/60Hz at 3.1 amps

Note: Refer to the rear panel of the MC58 for the correct voltage.

Dimensions

Front Panel: 17-1/2 inches (44.5cm) wide, 7-1/16 inches (17.9cm) high. Depth behind front mounting panel is 20 inches (50.8cm) including clearance for connectors. Panel clearance required in front of mounting panel is 3/4 inches (1.9cm).

Weight

40 pounds (18.1Kg) net, 58 pounds (28.3Kg) in shipping carton

Packing Instructions

In the event it is necessary to repack the equipment for shipment, the equipment must be packed exactly as shown below. It is very important that the four plastic feet are attached to the bottom of the equipment. Three #10 x 2-1/4" screws and washers must be used to fasten the unit securely to the bottom pad and wood skid. This will ensure the proper equipment location on the bottom pad. Failure to do this will result in shipping damage.

Use the original shipping carton and interior parts only if they are all in good serviceable condition. If a shipping carton or any of the interior part(s) are needed, please call or write Customer Service Department of McIntosh Laboratory. Please see the Part List for the correct part numbers.

Quantity	Part Number	Description
1	033888	Shipping carton only
4	033887	End cap (Foam pad)
1	033697	Inside carton only
1	033725	Top Pad
1	034008	Bottom pad
2	017218	Plastic foot (spacer)
1	033699	Wood skid
2	101169	#10 x 2-1/4" Wood screw
2	104033	#10 x 1-3/4" Wood screw
4	017218	Plastic foot
4	100159	#10-32 x 3/4" Machine screw
4	104083	#10 x 7/16" Flat washer
1	040572	Shipping carton complete with all the above parts

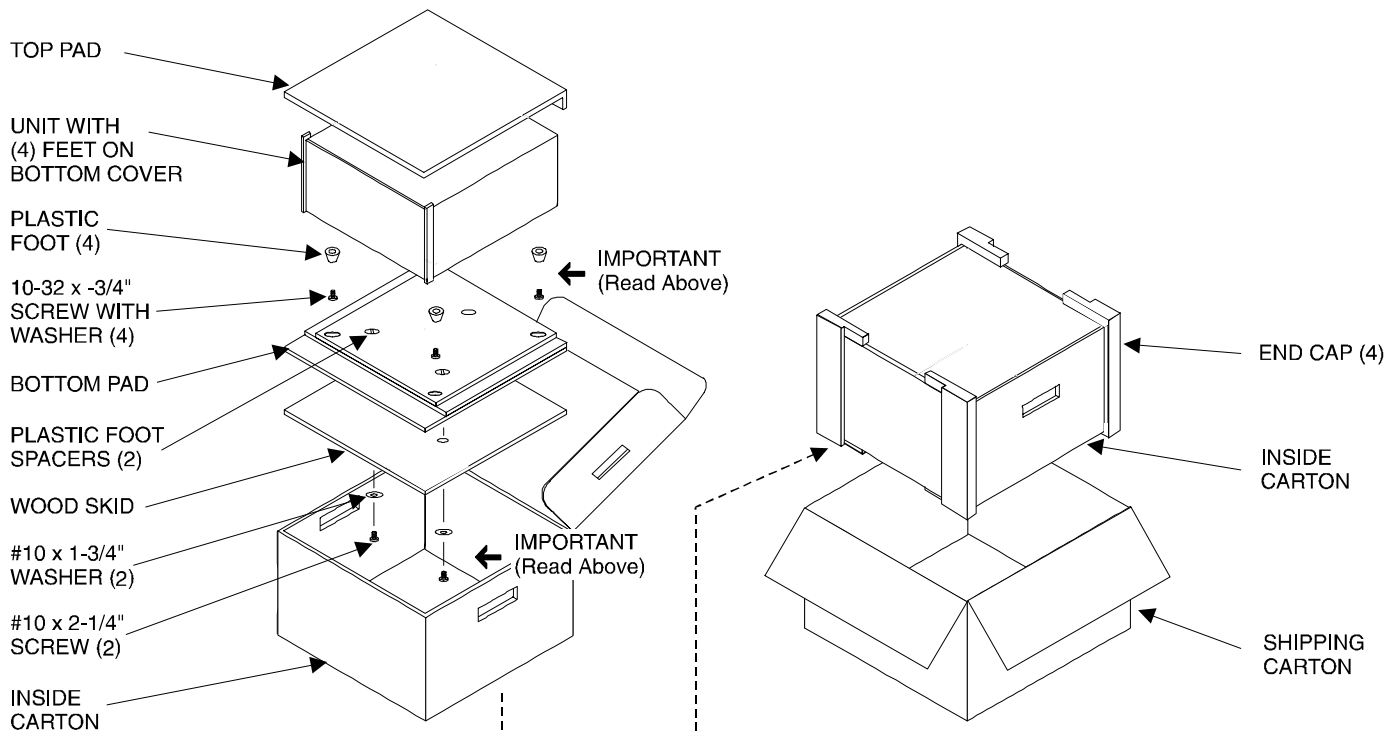

McIntosh[®]

McIntosh Laboratory, Inc.
2 Chambers Street
Binghamton, NY 13903

McIntosh Part No. 040726